

Service Guide

Summer 2024



Valid as of
31 March 2024

Intro

Editorial

Dear valued Swiss WorldCargo Customer,

The upcoming summer season is a special and exciting one! In only a few months we are going to serve three new long-haul destinations: Washington as of 28 March 2024 with a daily flight; Seoul as of 7 May 2024 with three flights per week; and Toronto as of 10 May with five flights per week. For you, our loyal customers, this means even more global connection for your cargo. All three cities connect important business hubs in the North America and Asia regions, and we look forward to start transporting your precious freight to these new destinations soon.

The addition of new destinations to our network is not the only exciting news. In fact, in autumn 2023, we announced that Swiss WorldCargo and Sonoco ThermoSafe signed a global master lease agreement for the deployment of Sonoco ThermoSafe's innovative Pegasus ULD® temperature-controlled bulk shipping container, which is both lighter and more damage-resistant than traditional metal containers. We are happy to keep offering the Pegasus ULD as part of our transportation solutions for rental in our Summer Timetable 2024, further ensuring safe and efficient transport of time- and temperature-sensitive healthcare cargo.

There can never be too much news on the sustainability front! Earlier this month it was announced that SWISS and the Lufthansa Group have entered a strategic partnership with Climeworks, making the two airlines the first ones in the world to join forces with the Swiss-based company. Climeworks has developed a pioneering technology to remove CO2 directly from the air and then store it permanently underground via a process known as Direct Air Capture or DAC. DAC is not only a critical measure, but also a highly relevant innovation for the future production of synthetic SAF. We are very excited to support the scale-up of this key technology for the aviation sector and, together with Climeworks, to take off into a more sustainable future.

Last but not least, our revised modular and commodity-based airfreight service structure is live since 1 July 2023, offering you more flexibility through a wide range of tailored solutions designed to fully meet your unique airfreight needs. Over the past few months, we focused on enhancing our new offering structure: for example, we added two new options for an AWB level compensation of your shipment with SAF and CO2 offsetting through our Green Choice add-on service, and we enabled the bookability of our SWISS Vulnerables product with Dangerous Goods and X-Presso as transportation solutions. I am very enthusiastic about further enhancements that we are currently working on that will bring you even more added value.

Intro

Editorial

I would like to thank you for your continued support and the long-lasting partnership that we are privileged to share with you every day. We look forward to continuing to provide you with our high quality, reliable and expert service in the months ahead.

Our Summer Timetable 2024 will come into effect as of 31 March 2024. Our Service Guide provides you with accurate and up-to-date information about the products and solutions we can offer you, including details on our aircraft and ground-handling partners. Please visit our website [swissworldcargo.com](https://www.swissworldcargo.com) to find out about our latest news.

We look forward to a continued successful partnership and collaboration with you. We care for your cargo.

Kind regards,

Lorenzo Stoll
Head of Cargo
Swiss International Air Lines Ltd.

Intro

Contents

Branded Products

- Modular airfreight services	7
- SWISS General Cargo	8
- SWISS Valuables	9
- SWISS Vulnerables	10
- SWISS Pharma & Healthcare	11
- SWISS Perishables	12
- SWISS Live Animals	13
- SWISS Mail	14
- Product combinability	15

Transportation Solutions

- Celsius Active	16
- Container Portfolio	17-19
- Celsius Passive	20
- X-Presso	21-22
- Dangerous Goods	23

Add-on-Services

- Green Choice	24-25
- Home Delivery	26
- Active Tracking Devices	27-29

Operational

- Overview of other Services	30
- Acceptance cut-off times (export)	31-33
- Delivery times (import)	34-35
- Connecting times (transfer)	36-40

Fleet

- Boeing 777-300 (77W)	41
- Airbus A340-300 (343)	42
- Airbus A330-300 (333)	43
- Airbus A321-111 (321)	44
- Airbus A321neo (32Q)	45
- Airbus A320-214 (320)	46
- Airbus A320neo (32N)	47
- Airbus A220-100 (221)	48-49
- Airbus A220-300 (223)	50-51
- Embraer 190 (E90)	52-53
- Embraer 190-E2 (290)	54-55
- Embraer 195-E2 (295)	56-57
- Edelweiss Airbus A320-214 (32E)	58

Unit Load Devices (ULD)

- Overview	59-60
- Detailed information	61-64

Cooling Unit Load Devices

- Detailed information	65-71
------------------------	-------

Packagings

- Detailed information	72-73
------------------------	-------

Insurance

- General information	74
- Goods of all kinds	75-77
- Species (SWISS Valuables)	78-80
- Exclusions and claims	81-82

Your cargo contacts

83-87

Calendar

88

Intro

Philosophy

A worldwide standard

SWISS has developed its entire product and service philosophy on the basis of universal Swiss values such as friendliness, punctuality, reliability, safety and security, innovation, tradition, efficiency and the keenest attention to detail. It has done so with the clear aim of being a leading European airline that is active all over the world and is “best in class” in all its business areas – not just for passengers, but for cargo, too.

Added value

Adding value is one of Swiss WorldCargo's paramount objectives. As an internationally-active provider of airfreight capacity, SWISS cargo division creates genuine added value for its customers through its specialist expertise, its commitment to quality and its innovative skills.

Intro

Philosophy

Airport-to-airport

Swiss WorldCargo focuses on globally marketing cargo capacity between two or more airports, and offers an airfreight network that stretches to more than 130 destinations in over 80 countries. Its network of air services is supplemented by daily truck connections between key business centres.

Flown as planned

With its guaranteed acceptance, transfer and delivery times and its carefully-selected ground handling partners, SWISS WorldCargo offers the firmest of commitments that all your consignments will be transported exactly as they are booked.

Seamless

Swiss WorldCargo does not market its own logistics concepts: it integrates its services seamlessly and precisely into its customers' supply systems and chains, to ensure that its total attention to safety and security extends to its customers' planning too.

Supervised

Seamless integration will only be half as effective unless it is combined with continuous monitoring and a swift and proactive response to any irregularities that occur. That's why Swiss WorldCargo provides its "Match" online consignment tracking system for its customers – to let them know in real time exactly where their shipment is currently located on the SWISS network.

Customer-centric

Swiss WorldCargo makes full use of its extensive experience and expertise to provide innovative concepts that are specifically tailored to its forward-looking customers and their particular airfreight needs.

Swiss WorldCargo offers airfreight products that include SWISS General Cargo, SWISS Valuables, SWISS Vulnerables, SWISS Pharma & Healthcare, SWISS Perishables, SWISS Live Animals and SWISS Mail.

In addition, we offer transportation solutions, such as X-Presso, Celsius Active, Celsius Passive, and Dangerous Goods, and add-ons like Green Choice, Home Delivery, and Active Tracking Devices

For further details, please visit swissworldcargo.com

Branded Products

Transportation Solutions and Add-on-services

Modular airfreight services

Swiss WorldCargo addresses the shipping needs of different commodities. We will provide you with flexible, scalable solutions that can be dynamically adapted to the changing needs of your goods.

Design your own air cargo service tailored to your needs.

1. The What (Products)

Pick from one of our branded products based on the commodity you are transporting.

2. The How (Transportation Solutions)

Select from our transportation solutions how do you wish to transport your shipment.

3. The Extra (Add-on-services)

Customize your shipment with one of our add-on services to match your needs.

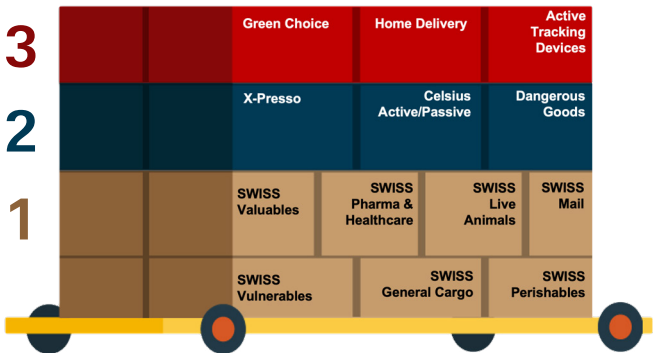

Branded Products

SWISS General Cargo



Let your shipments benefit from Swiss quality and reliability of service

Transporting goods of all kinds requires a high level of accuracy to ensure a reliable transportation service. SWISS General Cargo offers exactly that. You can rely on SWISS quality when we transport your consignment by air or by road. Throughout our global network we can provide excellent service tailored to meet your requirements.

SWISS General Cargo is suitable for any air cargo consignment for which customers require special quality and expertise. We focus on quality, reliability and efficiency, as our flights follow a strict schedule and you can count on our punctuality. **Our reliability. For your quality transportation.**

Why SWISS General Cargo?

Global network of excellence: With our extensive global network, we offer seamless air and truck connections between key business centers worldwide. Whether it's across continents or within a region, count on us to deliver your shipments promptly and efficiently.

Punctuality at its best: We take pride in our stable flight schedules and high 'flown as booked' rate ensuring your cargo reaches its destination on time, every time. Trust in our punctuality to keep your supply chain running smoothly.

Hub in Zurich: Our state-of-the-art hub in Zurich is designed for seamless integration into your supply chain, allowing for a quick transit time of up to 10 hours. The combination of short distances between the warehouse and aircraft positions, along with top-notch operational and warehouse handling, ensures your cargo is handled with the utmost efficiency and care.

No weight limitations: SWISS General Cargo has no weight limitations (subject to aircraft type restrictions), making it the ideal choice for a wide range of cargo shipments.

Branded Products

SWISS Valuables



Premium solution for highly secured cargo transport

The premium solution for your highly secured supply chain. In today's world, valuable consignments encompass more than just traditional assets like gold, money, and precious gems. With the ever-increasing pace of life, there is a growing demand for transporting highly confidential documents, exquisite art pieces, and valuable collections. We understand the importance of mitigating risks associated with transporting high-value cargo. That's why our valuable product surpasses the security standards set by IATA. When you choose us to transport your valuables by air, you can trust in our commitment to upholding Switzerland's time-honored values of discretion, reliability, and technical expertise. **Our discretion. For your shipment's security.**

Why SWISS Valuables?

Unrivalled security measures: Exceeding IATA's security standards, we uphold Switzerland's values of discretion, reliability, and technical expertise, ensuring your valuable cargo is in safe hands. The four-eyes principle is followed during handling, transportation, and aircraft loading/unloading processes, ensuring thorough checks at every stage.

Discretion at every step: Benefit from special storage with camera surveillance, sealed containers, and highly secured transport for on-time delivery. We also accept dangerous goods, subject to local restrictions and IATA DG regulations.

Comprehensive protection: Our global network follows rigorous handling standards, storing your cargo in constantly monitored facilities, and delivering only to authorized consignees. With SWISS Valuables, you can rely on tarmac escort to and from the aircraft.

Reliable transportation hub: Our dedicated secure hub reduces potential risks with a separate and highly secured storage facility. Our Zurich hub offers short turnaround times and meticulous checks at every stage, ensuring efficient and secure transportation.

Branded Products

SWISS Vulnerables

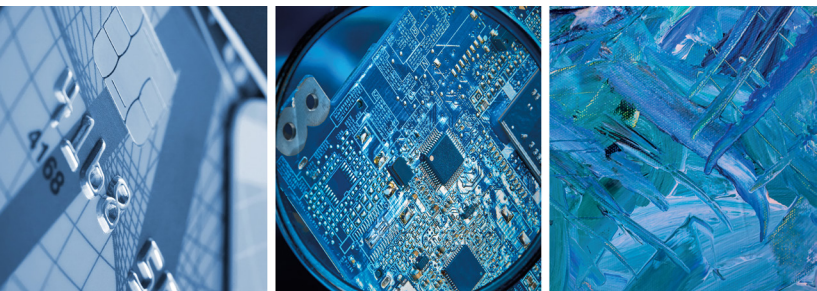

Protect your shipment without compromise

The hi-tech, the fine art and the high-end fashion and other specialised industries manufacturing complex and delicate products require reliable and protected logistics chains. Careful handling, product integrity, theft prevention, discretion and confidentiality are key requirements when it comes to air freight solutions for these extremely vulnerable products. With SWISS Vulnerables we offer substantially high protection against tempering. **Our caution. For your cargo protection.**

Why SWISS Vulnerables?

Enhanced theft protection: Our distinctive storage facilities come with special attendance and additional security checks both before departure and upon landing, ensuring your cargo's safety throughout the journey.

Secured transport processes: Specialised transport and handling processes guarantee that your cargo remains secure en route until its destination.

Tailored surveillance and loading: Our dedicated storage, surveillance, and precise loading procedures ensure that your cargo is shielded at every stage of its journey.

Skilled global personnel: Our highly trained and skilled personnel across the globe are dedicated to ensuring the security and safety of your shipment.

Capacity access: Enjoy preferential access to capacity without weight limitations (subject to aircraft type restrictions), providing you with flexibility and convenience.

Consistent quality standards: Benefit from our globally consistent handling and quality standards that reflect our commitment to excellence.

Branded Products

SWISS Pharma & Healthcare



Rely on us to safeguard your product integrity

We recognize the crucial importance of transporting life-saving medicines, temperature-sensitive vaccines, and essential healthcare products with the highest level of precision and care. In a world where freshness, quality, and timeliness are paramount, our tailored airfreight solution ensures that your pharmaceutical and healthcare goods reach their destination in optimal condition. We understand the delicate nature of these commodities and maintain stringent measures to preserve their integrity throughout the entire journey. Trust us for precision and care in transporting your pharmaceutical and healthcare goods, trust our SWISS Pharma & Healthcare product. **Our expertise. For your product integrity.**

Why SWISS Pharma & Healthcare?

Customised Approach: Tailored to your unique needs, our offering provides a reliable and secure transportation solution for your sensitive shipments.

Temperature Solutions: Our transportation solutions ensure temperature maintenance throughout the entire transportation chain. Choose the solution that is best fitting your requirements:

- **Celsius Active** for the pharmaceutical temperature-controlled supply chain, demanding the strictest temperature maintenance and active temperature control throughout the entire transportation chain.
- **Celsius Passive** for temperature-sensitive pharmaceutical shipments, requiring temperature support for the storage and transportation at origin, transfer and destination.

Enhanced Services: Benefit from prioritized ground handling, the possibility to book express speed, short transit times, high flexibility, preferred flight capacity access, and global quality control.

Certifications: We are IATA CEIV Pharma certified as an airline, and our hub in Zurich holds the GDP compliance certification by Swissmedic and IATA CEIV Pharma certification.

Expert Staff: Our worldwide trained team provides professional shipment handling, ensuring the highest level of competence.

Branded Products

SWISS Perishables



Trust us to always keep your perishables fresh

In a world where freshness, quality, and timeliness are paramount, the transportation of perishable goods demands utmost precision and expertise. At Swiss WorldCargo, we understand the critical nature of transporting delicate fruits, vegetables, and meats. We ensure your delicate produce maintains its freshness and quality throughout the journey.

We recognize the importance of every minute, and our streamlined supply chain guarantees swift and efficient delivery, minimizing any potential spoilage while adhering to the highest standards of care. **Our efficiency. For your consignments' freshness.**

Why SWISS Perishables?

Precision in perishables: Our team's expertise guarantees that your delicate fruits, flowers, vegetables, fish, seafood and meats remain as fresh as when they were harvested. From handling to transportation, we uphold the highest standards of care.

Efficiency in every detail: Benefit from seamless air and truck connections between global business centers. Our processes adhere to countries' regulations and we ensure that documentation is provided according to authorities' requirements.

Seamless integration: We seamlessly integrate into your supply chain, ensuring that your shipments move smoothly. Our commitment to high-quality handling standards means your goods are treated with the utmost care and attention.

Global consistency: No matter where your goods are headed, our highly skilled personnel worldwide ensure that your perishables receive the same level of care. Our integrated online consignment tracking system keeps you informed every step of the way.

Hub of excellence: Our Zurich hub offers dedicated handling and storage for perishables. Short distances between our warehouse and aircraft positions, along with efficient processes, minimize exposure to outside conditions, preserving your goods' quality.

Branded Products

SWISS Live Animals



Entrust your beloved pets and animals to our attentive care for a worry-free journey

SWISS Live Animals is the premium service for transporting live animals with utmost care and expertise. We understand the importance of ensuring the well-being and safety of your precious animals during their journey. With a team of trained experts and specialized facilities, we go above and beyond to provide a seamless and stress-free experience for both you and your animals. Our fast and efficient transportation options, adherence to strict regulations, and commitment to animal welfare make us the preferred choice for transporting a wide range of live animals, including hatching eggs, tropical animals, zoo animals, pets, and more. Trust SWISS Live Animals to deliver exceptional service, peace of mind, and the highest level of care for your beloved companions. **Our care. For your peace of mind.**

Why SWISS Live Animals?

Specialized facilities and staff: The animal center in our Zurich hub is equipped with dedicated staff who are trained to provide maximum care for the animals. From ensuring a stress-free environment to offering water and additional food upon request, the expertise of staff ensures the well-being of the animals throughout their journey.

Priority and expert handling: Live animal shipments receive the highest transportation priority, guaranteeing their well-being and timely transportation. Our team follows strict IATA Live Animal Regulations and implements specific handling processes for their safety and comfort.

Crew attention: Our crew members prioritize the animals' well-being, maintaining the appropriate ambient temperature for a comfortable journey.

Constant monitoring: Our dedicated staff checks on the well-being of the animals at every step of their journey. We prioritize their comfort and safety throughout the transportation process.

Branded Products

SWISS Mail



Deliver mail swiftly in transparency

The airmail parcel business is constantly increasing due to a phenomenal potential market volume and growth for national postal organisations. The worldwide major postal organisations are already prominently active in this high-potential business sector. They are busy ensuring greater vertical integration and control over their operation processes to secure a leading role in the global logistics arena and position themselves to offer integrated international Express Mail Services (EMS), Priority Mail (Airmail) or Non-Priority Mail (S.A.L).

Airmail services have their own special needs – whether they are Express Mail Services (EMS), Priority Mail (Airmail) or Non-Priority Mail (S.A.L) – exemplary efficiency is just as essential as absolute discretion, be it letters or parcels. **Our consistency. For your transparent delivery.**

Why SWISS Mail?

By choosing SWISS Mail, you benefit from unparalleled transparency, which can transform your business operations positively. Here's how:

Empowerment: You now have the ability to provide your end customers with full information, a vital aspect in today's competitive landscape. Transparency builds trust, and we understand how important it is to know exactly where your mail is at any given time.

Real-time adaptation: With continuous updates on your mail's current status, you can act swiftly in response to any unforeseen circumstances. Whether it's flight cancellations or backlogs, you have the flexibility to adjust production or re-route traffic temporarily to ensure smooth operations.

Branded Products

Product combinability

Transportation Solutions	X-Presso	Celsius Active	Celsius Passive	Dangerous Goods
SWISS General Cargo	✓	✓	✓	✓
SWISS Valuables	X	X	X	✓
SWISS Vulnerables	✓	X	X	✓
SWISS Pharma & Healthcare	✓	✓	✓	✓
SWISS Perishables	✓	✓	✓	X
SWISS Live Animals	✓	X	X	X
SWISS Mail	X	X	X	X

Add-on Services	Green Choice	Direct Delivery	Active Tracking Devices
SWISS General Cargo	✓	✓	✓
SWISS Valuables	✓	X	✓
SWISS Vulnerables	✓	X	✓
SWISS Pharma & Healthcare	✓	✓	✓
SWISS Perishables	✓	✓	✓
SWISS Live Animals	✓	X	✓
SWISS Mail	X	X	X

Transportation Solutions

Celsius Active

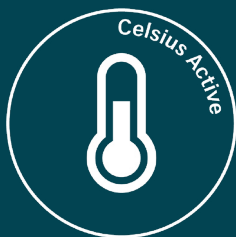

For your temperature controlled supply chain

The market for pharmaceutical and healthcare products continues to grow and shows a sustainable and sound development. As speed to market is essential, the healthcare industry is increasingly relying on air cargo. The challenge for all the involved parties in the supply chain is to keep healthcare products within the required temperature range to ensure an uninterrupted cool chain and preserve the quality of the product.

Maintaining cool chain integrity is a core element in the transportation of temperature controlled pharmaceutical products. To maintain the product temperature along the supply chain, customers are choosing an 'active' temperature controlled container based on technologies like compressor cooling, electric heating or dry ice refrigeration.

Swiss WorldCargo's Celsius Active is a custom-made, high-quality solution for your shipments that require seamless transportation in active temperature controlled containers.

Why Celsius Active?

Our Product

- Transport in active temperature-controlled containers for consistency in temperature ranges from -20 °C to +20 °C
- Quality control via check sheet at the airport of departure, transfer and arrival
- A global network of selected audited stations
- Thermo truck network available
- Worldwide personnel trained in temperature controlled container handling
- Uniform handling standards worldwide
- Dangerous goods accepted (local restrictions and IATA DG regulations apply)
- Integrated online consignment tracking system

Transportation Solutions

Container Portfolio

Envirotainer

LD9 Envirotainer RAP t2

Thermostat-controlled heat exchanger with dry ice as refrigerant

Temperature range -20 °C to +20 °C

See technical details on page 65

LD3 Envirotainer RKN t2

Technology thermostat-controlled heat exchanger with dry ice as refrigerant

Temperature range -20 °C to +20 °C

See technical details on page 65

LD9 Envirotainer RAP e2

Fully redundant thermostat-controlled air conditioning system with compressor cooling and electrical heating

Temperature range 0 °C to +25 °C

See technical details on page 66

LD9 Envirotainer Releye RAP

Fully redundant thermostat-controlled air conditioning system with compressor cooling and electrical heating

Temperature range +5 °C and +20 °C

See technical details on page 66

LD11 Envirotainer Releye RLP

Fully redundant thermostat-controlled air conditioning system with compressor cooling and electrical heating

Temperature range +5 °C and +20 °C

See technical details on page 67

LD3 Envirotainer RKN e1

Thermostat-controlled compressor cooling and electrical heating

Temperature range 0 °C to +20 °C

See technical details on page 67

Transportation Solutions

Container Portfolio

Sonoco ThermoSafe

LD3 ThermoSafe, Pegasus

Advanced passive temperature controlled system

Temperature range +2 °C to +8 °C

See technical details on page 68

CSafe

LD9 CSafe RAP

Thermostatic controlled compressor cooling and electrical storage

Temperature range +4°C to +25°C

See technical details on page 69

LD3 CSafe RKN

Thermostat-controlled compressor cooling and electrical heating

Temperature range +4 °C to +25 °C

See technical details on page 69

DoKaSch

LD9 DoKasch RAP

Fully redundant thermostat-controlled air conditioning system with compressor cooling and electrical heating

Temperature range +2 °C to +30 °C

See technical details on page 70

LD3 DoKasch RKN

Thermostat-controlled compressor cooling and electrical heating

Temperature range +2 °C to +30 °C

See technical details on page 70

Transportation Solutions

Container Portfolio

Swiss Airtainer

LD3 Swiss Airtainer RKN

Fully redundant thermostat-controlled air conditioning system with compressor, cooling and electrical heating

Temperature range +5 °C and +25 °C

See technical details on page 71

Transportation Solutions

Celsius Passive

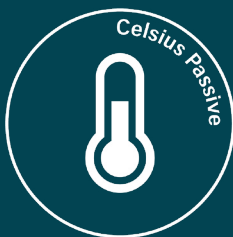

For your temperature sensitive supply chain

Customers around the globe are investing more and more resources in sophisticated passive packaging solutions for their time and temperature sensitive shipments.

However, it is not all about packaging, these healthcare shipments rely on high quality standardised processes, speed and adequate storage, wherever possible, throughout the supply chain.

Why Celsius Passive?

Our Product

- Choice between the four official IATA temperature ranges: controlled frozen (FRO -20 °C), controlled cool (COL +2 °C to +8 °C), controlled room temperature (CRT +15 °C to +25 °C) and controlled extended room temperature (ERT +2 °C to +25 °C) as well as ambient storage
- A global network of selected audited stations
- Thermo truck network available
- Skilled and trained personnel worldwide
- Uniform handling and quality standards worldwide
- Dangerous goods accepted (local restrictions and IATA DG regulations apply)
- Integrated online consignment tracking system

Transportation Solutions

X-Presso



For your time-critical supply chain

When time is of the essence, trust X-Presso to deliver your shipments with unrivaled speed and precision. We understand the importance of urgent deliveries in today's fast-paced world, and that's why we've developed X-Presso – a transportation solution designed to meet your time-critical supply chain needs. With X-Presso, you can enjoy blazing-fast transit times, dedicated handling processes, and seamless integration with your existing products. Say goodbye to long shipping delays and embrace the power of X-Presso for your express shipping requirements. No matter the nature of your cargo, X-Presso enables faster shipping, freeing you from limitations based on the commodity type.

Why X-Presso?

Our Product

- Extremely short acceptance, transfer and delivery times
- Short notice reservations right up to the final acceptance deadline
- Skilled personnel worldwide
- Guaranteed space confirmation shortly before departure
- Globally consistent handling and quality standards
- No weight limitations (aircraft type restrictions apply)
- Globally consistent handling and quality standards
- An integrated online consignment tracking system

Transportation Solutions

X-Presso

X-Presso facts

Capacity Features	X-Presso (XPS)	X-Presso XL (XPL)	X-Presso 'One Hour Option' (XPT)
Preferred space access	Yes Intercontinental: 200 kg/1 m ³ Europe: depends on aircraft type	Yes Worldwide: 500 kg/2.5 m ³ depends on aircraft type	Yes Intercontinental: 200 kg/1 m ³ Europe: depends on aircraft type
Booking tolerance	+/-20%	+/-20%	+/-20%
Maximum weight/m³ per consignment	Depends on aircraft type	Depends on aircraft type	500 kg/2.5 m ³ per inbound flight
Maximum weight per piece	50 kg	No limits	99 kg for loose shipments
Maximum dimensions per item	depends on aircraft type	depends on aircraft type	depends on aircraft type
BUP	Yes	Yes, except BUP with dangerous goods	Yes
Transport of special cargo (AVI, DGR, etc.)	No, except following Dangerous Goods: RRE, REQ, RDS, MAG, ELI and ELM (without dry-ice)	Yes	No, except following Dangerous Goods: RRE, REQ, RDS, MAG, ELI and ELM (without dry-ice)
Trucks services	Yes	Yes	Yes

Handling features	X-Presso (XPS)	X-Presso XL (XPL)	X-Presso 'One Hour Option' (XPT)
Latest acceptance times "ready for carriage"	90 min *	120 min * for loose items For dangerous goods and live animals, special acceptance conditions apply	90 min for XPS in combination with XPT 120 min for XPL in combination with XPT
Transfer times	90 min *	120 min *	60-89 min for XPS in combination with XPT 60-119 min for XPL in combination with XPT
Delivery times after landing	90 min *	120 min *	90 min for XPS in combination with XPT 120 min for XPL in combination with XPT
Special consignment labeling by the customers	X-Presso tags and stickers	X-Presso tags and stickers	X-Presso tags and stickers
Separate handling process	Yes	Yes	Yes

* Local offers may differ from standard service. Local conditions may apply.

Transportation Solutions

Dangerous Goods



Care and expertise: Efficiently, quickly, safely and securely

Dangerous goods in the air cargo industry are articles or substances that are capable of posing a risk to health, safety, property or the environment, and which are regulated and classified in the IATA Dangerous Goods Regulations. When it comes to shipping dangerous goods, shippers have to be fully aware and trained of what it entails, because ultimately, they are responsible for:

- Understanding restrictions pertaining to shipped dangerous goods
- Selecting the relevant compliant and safe packaging
- Labelling and marking dangerous goods as per IATA regulation
- Correctly completing the relevant documentation

Every year we transport around 16'000 tonnes of dangerous goods on board of our aircrafts. And thanks to our many years of expertise and our fully trained staff, we can grant you peace of mind in full compliance with the ICAO and IATA rules and regulations. You can rely on our knowledge and expert advice for booking, handling and transporting dangerous goods, because we care for your cargo.

Dangerous Goods compliance with regulations

- Compliance to the highest and latest safety & environmental standards
- Dedicated process to accept and handle dangerous goods, with specific acceptance times
- Extensive network
- Tracking system for additional peace of mind
- Fully trained staff worldwide. All personnel worldwide involved in dangerous goods handling are checked and monitored, whether their training is either certified by the local Civil Aviation Authorities or by IATA

Add-on-Services

Green Choice

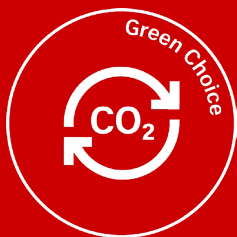

For your shipments with reduced carbon emissions

We are committed to offering more sustainable options to meet your shipping needs. With Green Choice, you can reduce the CO₂ emissions of your shipments through the purchase of Sustainable Aviation Fuel (SAF) or you can reduce the generated emissions by investing in climate protection projects.

Choose your compensation package

Discover our range of compensation packages designed to help you or your customers reduce CO₂ emissions of your goods, available at both the Airwaybill (AWB) level and in bulk. We offer flexible options that allow you to choose the level of Sustainable Aviation Fuel (SAF) and CO₂ offsetting into climate protection projects that best suits your needs. Whether you prefer compensating on individual AWBs or consolidating multiple shipments under a bulk agreement, we have the right solution for you. Take a closer look at our packages below:

AWB Level Compensation

Choose from three Green Choice options available for every shipment with an AWB. Ensure to book the compensation before shipment departure.

- Option 1: 80% SAF and 20% CO₂ offsetting
- Option 2: 40% SAF and 60% CO₂ offsetting
- Option 3: 20% SAF and 80% CO₂ offsetting
- Option 2: 10% SAF and 90% CO₂ offsetting
- Option 3: 100% CO₂ offsetting

The AWB compensation applies to the entire routing and the final shipped gross weight of the shipment. Partial routing or partial shipment weight compensation is not possible, and fixed amount compensation is also not available.

Add-on-Services

Green Choice



Bulk Agreement

This leads to a maximum CO₂ reduction through SAF of 80% (no overcompensation) and an offset of the remaining 20% through investing in climate protection projects. In case your customer is interested in other carbon reduction options, we can look into this and find a solution.

In addition, with the option of buying SAF, customers can contribute to their own sustainability targets. For the bought SAF, customers get an independently audited certificate of the reduced amount that they can use for reaching their target of emissions reduction in their Scope 3 carbon report.

Add-on-Services

Home Delivery



For your peace of mind up to your warehouse

With our competitive network of trucks and a centralized hub in Zurich, Europe, we ensure a seamless connection from arrival to your final destination. The Home Delivery option can be added to the transportation of temperature-sensitive products, and our trucks are equipped with different temperature settings for optimal care.

Experience the benefits of our value proposition, including direct delivery to your own warehouse, temperature-controlled trucking vehicles, and short transfer and delivery times aligned with flight schedules. Choose between regular home delivery or ad-hoc options. Say goodbye to long waiting times and broken cold chains: our prompt truck arrangements and on-time deliveries with the required temperature ensure your cargo's safety.

Streamlined delivery solutions tailored to your needs

- Direct delivery to your warehouse
- Competitive network of trucks with a centralized hub in Zurich, Europe
- Flexibility to choose between regular home delivery booking or ad-hoc options
- Seamless connection from arrival to final destination
- Ability to combine with temperature-sensitive products
- Trucks equipped with different temperature settings
- Quality Management system ensuring continuous improvement and risk mitigation
- Efficient internal processes to prevent irregularities
- Knowledgeable customer service team available for inquiries
- Experienced support team for handling irregularities and issues

Add-on-Services

Active Tracking Devices



For keeping control of your goods at all times

The need for timely information and transparency is a key requirement in supply chain logistics, since any number of cargo irregularities can occur during transportation, despite careful planning.

That is why we allow the transportation of SWISS-approved active tracking devices (ATDs). Additionally, we provide a 24/7 dedicated intervention team able to react to any ATD deviation alarm worldwide based on your request.

The use of any ATD listed below requires the customer to book their shipment with the SHC of EMD.

IATA regulations on lithium batteries are in effect, if more than 2 devices per package or more than 2 packages containing such devices, all packages containing such devices must be marked with the lithium battery mark and the «Nature and quantity of Goods Box» on the AWB must show the words «Lithium ion batteries in compliance with Section II of PI 967».

Contact

You will find your regional contact on our website at swissworldcargo.com

Add-on-Services

Active Tracking Devices

Active Tracking Devices

The need for timely information and transparency is a key requirement in supply chain logistics, since any number of cargo irregularities can occur during transportation, despite careful planning.

That is why we allow the transportation of SWISS-approved active tracking devices (ATDs). Additionally, we provide a 24/7 dedicated intervention team able to react to any ATD deviation alarm worldwide based on your request.

The use of any ATD listed below requires the customer to book their shipment with the SHC of EMD.

IATA regulations on lithium batteries are in effect.

- 7P Solutions GD100/GL300/GL300W
(SWC authorizes the GL300series ONLY WITHOUT external extended batteries)
- ASPION loggers (all models)
- BeeSense Flex* *
- BeOn A1
- Berlinger Smart Monitor SHIP L / Berlinger Smart Monitor SHIP S
- Berlinger SmartMonitor SHIP M*
- Berlinger SmartPoint
- Bosch TDL 140
- Calamp SC1102/SC1004*
- CargoSense - Toshiba Environmental Logger
- Cartasense U-Sensor
- Controlant CO 10.01
- Controlant Saga* *, Saga-H* *, and Saga-P* *
- ELPRO LIBERO Cx series
- ELPRO LIBERO GE, GL, GS, GH*
- ELPRO LIBERO GF
- Copeland GO Real-Time Tracker(s), inc 4G/5G LT and 4G/5G GLOBAL versions
- Copeland GO Real-Time Tracker(s), inc 4G/5G LT versions and GO Bluetooth Plus Loggers
- Frigga T7, Frigga B9x and V5 series
- Hanhaa Parcelive
- HERE Premier Tracker
- Hive-Zox - BEEconIoT* *
- HiveTracker BEEconIoT with Probe
- Honeywell Gateway/Sensor Tags
- Intelyt iTAG, Intelyt iCHIME
- Kelvin Pro /Track IT, Kelvin S100, M200 & M300
- Kirschen Global Security A-Type "Schenker Smartbox" Brieftrace
- Kizy K-2 Tracker
- KN Blue Sensor
- Kylos Air
- Lansmont_Saver_3X90* (if using alkaline battery option)
- Modum MODsense T

Add-on-Services

Active Tracking Devices

- Monilog® EnDaL smart*** and MSD
- OnAsset Sentry 500 & Sentry 600 Flightsafe and Sentinel 100 & 100C
- Roambee Bee and BeeSense Air*
- Roambee - BeeSense Modbus
- Sendum PT300D/PT300
- SenseAware 3000 and SenseAware M4 & ID tag
- Shipit
- SIT1002 tracker
- Sony VT-G100
- STRACKER Single Use PT35
- System Loco E4BL Bluetooth Temp/Humidity Data Logger
- System Loco HGD4 Temp Data Logger, GPS Tracker (alkaline)*
- T11013050 / TTGEO Ultra Alkaline*
- T11013070 / TTGEO Ultra Dry Ice Alkaline*
- Tec4Med CryoBeacon / SmartBeacon / TempBeacon
- TempTale GEO X (T11013210)
- TempTale GEO XE (T11013220)
- TempTale GEO XP (T11013230)
- TempTale GEO XEP (T11013240)
- Tive Solo 5G 7000 (lithium) / Tive Solo 5G 7100 (non-lithium)**
- ToolLive TL001
- Trackonomy FBB-2000/ Trackonomy FWB-2000
- Visilion Mobiam Tracker
- 7P GL300 series (SWC authorizes the GL300series ONLY WITHOUT external extended batteries)

(Last update: October 2023)

* AWB must include statement "Not restricted. Alkaline IATA DGR special provision SP A123." and "Not restricted as per Special Provision A123."

** AWB must include statement "Not restricted as per DGR Special Provision A199."

Note: According to IATA DGR 1.3, DG documentation and marking is the shipper's responsibility. Should a shipper decide not to take advantage of the new exception in IATA DGR SP A220 and deliver a consignment documented, marked or labeled as ELI or ELM, then a formal DG acceptance check sheet in accordance with LX CHM 6.1.12.1.1 / 6.1.12.3 must be issued upon cargo acceptance.

Note: As per IATA Dangerous Goods Regulations (DGR) 2021 Addendum A220. Packages containing COVID-19 pharmaceutical accompanied by data logger and or cargo tracking devices containing lithium batteries are not subject to the marking and documentation requirements of Section II Packaging Instruction 967 or 970, as applicable. This same package configuration, when consigned without the COVID-19 pharmaceutical for use or reuse, is also not subject to the marking and documentation requirements of Section II Packaging Instruction 967 or 970, providing prior arrangements have been made with the operator. Please contact your local Swiss WorldCargo office for information on repositioning empty packaging(s) that have real time tracking devices.

For an updated list of approved devices, please check our homepage [swissworldcargo.com/en/activetrackingdevices](https://www.swissworldcargo.com/en/activetrackingdevices)

Operational

Overview of other Services

Baggage shipped as Cargo

Do you have larger amounts of excess baggage? Send them with Swiss WorldCargo, the ideal solution for the transport of oversized and heavy baggage, bicycles, bulky goods, furniture etc. Please note the special acceptance deadlines.

Live Animals accompanying passenger

We do allow cats and dogs to travel with their owners in the cabin on most of the SWISS operated flights if the weight including the soft-sided bag does not exceed 8 kilogrammes. Otherwise, they may be transported in the hold as checked baggage or cargo.

Operational

Acceptance cut-off times (export)

Zurich		All contents in minutes		
		Narrow	Wide	Truck
Branded Products & Transportation Solutions				
SWISS General Cargo		180	240	240
SWISS Valuables				
Generally		90	90	90
Metals / goldbars / grains		120	120	120
SWISS Vulnerables		180	240	240
SWISS Pharma & Healthcare		180	240	240
SWISS Perishables		180	240	240
SWISS Live Animals		120	120	n/a
X-Presso				
XPS	< 50 kg/piece	90	90	90
XPL	> 50 kg/piece	120	120	120
XPL	With Dangerous Goods (DG)	120	120	120
Celsius Active		n/a	150	150
Celsius Passive		180	240	240
Dangerous Goods		Add 60	Add 60	Add 60
As SWISS General Cargo / SWISS Valuables / SWISS Vulnerables / SWISS Pharma & Healthcare / SWISS Perishables				
Security checks (Screening, hand search, sniffing, etc.)		Add 60	Add 60	Add 60

If X-Presso Transportation Solution is combined with SWISS Live Animals or Dangerous Goods, the shipment needs to be booked with a special handling code XPL.

Operational

Acceptance cut-off times (export)

Basel		All contents in minutes		
Branded Products & Transportation Solutions		Narrow	Wide	Truck
SWISS General Cargo		n/a	n/a	120
SWISS Valuables generally		n/a	n/a	90
SWISS Vulnerables		n/a	n/a	120
SWISS Pharma & Healthcare		n/a	n/a	120
SWISS Perishables		n/a	n/a	120
SWISS Live Animals		n/a	n/a	n/a
X-Presso				
XPS	< 50 kg/piece	n/a	n/a	n/a
XPL	> 50 kg/piece	n/a	n/a	90
Celsius Active		n/a	n/a	90
Celsius Passive		n/a	n/a	120
Dangerous Goods		n/a	n/a	Add 60
Security checks (Screening, hand search, sniffing, etc.)		n/a	n/a	Add 60
Geneva		All contents in minutes		
Branded Products & Transportation Solutions		Narrow	Wide	Truck
SWISS General Cargo		90	180	180
SWISS Valuables generally		90	120	n/a
SWISS Vulnerables		90	180	180
SWISS Pharma & Healthcare		90	180	180
SWISS Perishables		90	180	180
SWISS Live Animals		180	180	n/a
X-Presso				
XPS	< 500 kg	50	50	n/a
XPL	> 500 kg	90	90	90
XPL	(except A320)	n/a	120	120
Celsius Active		n/a	120	120
Celsius Passive		90	180	180
Dangerous Goods		Add 60	Add 60	Add 60
Security checks (Screening, hand search, sniffing, etc.)		Add 60	Add 60	Add 60

Operational

Acceptance cut-off times (export)

Berne (City Cargo Terminal)		All contents in minutes		
Branded Products & Transportation Solutions		Narrow	Wide	Truck
SWISS General Cargo		n/a	n/a	90
SWISS Valuables generally		n/a	n/a	90
SWISS Vulnerables		n/a	n/a	90
SWISS Pharma & Healthcare		n/a	n/a	90
SWISS Perishables		n/a	n/a	90
SWISS Live Animals		n/a	n/a	n/a
X-Presso				
XPS	< 50 kg/piece	n/a	n/a	90
XPL	> 50 kg/piece	n/a	n/a	90
Celsius Active		n/a	n/a	n/a
Celsius Passive		n/a	n/a	90
Dangerous Goods		n/a	n/a	Add 15
Security checks (Screening, hand search, sniffing, etc.)		n/a	n/a	n/a

Operational Delivery times (import)

Zurich		Earliest time ready for pick-up All contents in minutes after ATA	
Branded Products & Transportation Solutions	Documents		Goods
SWISS General Cargo	Narrowbody	90	240
SWISS Vulnerables	Widebody	90	360
SWISS Pharma & Healthcare	Truck	90	360
SWISS Valuables	Generally	90	90
SWISS Perishables	Flights ATA until 06:30h	90	11:00h
	Flights ATA 10:30-11:15h	90	15:45h
SWISS Live Animals		90	120
X-Presso			
XPS	< 50 kg/piece	90	90
XPL	> 50 kg/piece	90	120
Celsius Active		90	120
Celsius Passive	Narrowbody	90	240
	Widebody	90	360
	Truck	90	360

Basel		Earliest time ready for pick-up All contents in minutes after ATA	
Branded Products & Transportation Solutions	Documents		Goods
SWISS General Cargo	Narrowbody	n/a	n/a
SWISS Vulnerables	Widebody	n/a	n/a
SWISS Pharma & Healthcare	Truck	60	180
SWISS Perishables			
SWISS Valuables	Generally	60	90
SWISS Live Animals		n/a	n/a
X-Presso			
XPS	< 50 kg/piece	60	90
XPL	> 50 kg/piece	60	120
Celsius Active		60	180
Celsius Passive	Narrowbody	n/a	n/a
	Widebody	n/a	n/a
	Truck	60	180

Operational Delivery times (import)

Geneva	Earliest time ready for pick-up All contents in minutes after ATA		
Branded Products & Transportation Solutions	Documents	Goods	
SWISS General Cargo	Narrowbody	120	120
SWISS Vulnerables	Widebody	180	180
SWISS Pharma & Healthcare	Truck	100	100
SWISS Perishables			
SWISS Valuables	generally	120	120
SWISS Valuables		90	120
SWISS Live Animals		90	120
X-Presso			
XPS/XPL	loose 1-500 kg	50	50
XPS/XPL	loose > 500 kg	50	60
XPS/XPL	palletised	50	80
Celsius Active		180	180
Celsius Passive	Narrowbody	120	120
	Widebody	180	180
	Truck	100	100

Berne (City Cargo Terminal)	Earliest time ready for pick-up All contents in minutes after ATA		
Branded Products & Transportation Solutions	Documents	Goods	
SWISS General Cargo	Narrowbody	n/a	n/a
SWISS Vulnerables	Truck	60	90
SWISS Pharma & Healthcare			
SWISS Perishables			
SWISS Valuables	generally	60	90
SWISS Live Animals		n/a	n/a
X-Presso			
XPS	< 50 kg	60	90
XPL	> 50 kg	60	90
Celsius Active		n/a	n/a
Celsius Passive	Narrowbody	n/a	n/a
	Truck	60	90

Operational

Connecting times (transfer)

SWISS General Cargo / SWISS Pharma & Healthcare / SWISS Perishables

Zurich				
From	To	Narrowbody and bulk	320, 321	Widebody and truck
Narrowbody and Bulk		360 min	360 min	600 min
320, 321		360 min	360 min	600 min
Widebody and Truck		600 min	600 min	600 min

Note:

Through units generally 120 min

Through units "One Hour Option" 90 min

Basel				
From	To	Narrowbody and bulk	320, 321	Widebody and truck
Truck		180 min	180 min	360 min

Geneva				
From	To	Narrowbody and bulk	320, 321	Widebody and truck
Narrowbody		90 min	90 min	90 min
Truck		180 min	180 min	180 min
Widebody		180 min	180 min	180 min

Operational

Connecting times (transfer)

SWISS Valuables

Zurich	
From	To
All aircraft	All aircraft
	90 min

Geneva	
From	To
All aircraft	All aircraft
	90 min

SWISS Vulnerables

Zurich				
From	To	Narrowbody and bulk	320, 321	Widebody and truck
Narrowbody and Bulk		300 min	300 min	480 min
320, 321		300 min	300 min	480 min
Widebody and Truck		480 min	480 min	480 min

Basel				
From	To	Narrowbody and bulk	320, 321	Widebody and truck
Narrowbody		75 min	180 min	360 min
Truck		180 min	180 min	360 min
Widebody		360 min	360 min	360 min

Geneva				
From	To	Narrowbody and bulk	320, 321	Widebody and truck
Narrowbody		90 min	90 min	90 min
Truck		180 min	180 min	180 min
Widebody		180 min	180 min	180 min

Operational Connecting times (transfer)

SWISS Live Animals

Zurich	
From	To
All aircraft	All aircraft
	120 min

Geneva	
From	To
All aircraft	All aircraft
	120 min

X-Presso

Zurich		
	All aircraft	Truck
X-Presso	90 min	90 min
X-Presso XL	120 min	120 min

Basel			
	Narrowbody	Widebody	Truck
X-Presso	30 min	90 min	90 min
X-Presso XL	120 min	120 min	120 min

Geneva		
	All aircraft	Truck
X-Presso	90 min	90 min
X-Presso XL	120 min	120 min

Operational

Connecting times (transfer)

Celsius Active

Zurich				
From	To	Narrowbody and bulk	320, 321	Widebody and truck
Narrowbody and Bulk		n/a	n/a	n/a
320, 321		n/a	n/a	n/a
Widebody and Truck		n/a	n/a	120 min

Basel				
From	To	Narrowbody and bulk	320, 321	Widebody and truck
Truck		n/a	n/a	120 min

Geneva				
From	To	Narrowbody and bulk	320, 321	Widebody and truck
Narrowbody		n/a	n/a	n/a
Truck		n/a	n/a	n/a
Widebody		n/a	n/a	120 min

Operational

Connecting times (transfer)

Celsius Passive

Zurich				
From	To	Narrowbody and bulk	320, 321	Widebody and truck
Narrowbody and Bulk		360 min	360 min	600 min
320, 321		360 min	360 min	600 min
Widebody and Truck		600 min	600 min	600 min

Note:

Through units generally 120 min

Through units "One Hour Option" 90 min

Basel				
From	To	Narrowbody and bulk	320, 321	Widebody and truck
Truck		180 min	180 min	360 min

Geneva				
From	To	Narrowbody and bulk	320, 321	Widebody and truck
Narrowbody		90 min	90 min	90 min
Truck		180 min	180 min	180 min
Widebody		180 min	180 min	180 min

Fleet

Boeing 777-300ER (77W)

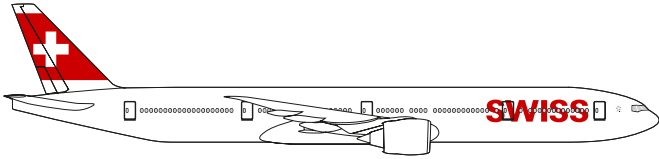

Area of operation

North and South America, Asia

Capacity for cargo and mail

Up to 25 tons with full passenger load

Weight and volume limitations

Compartments		1	2	3	4	5 Bulk	Security locker
Capacity	kg	15483	25838	23132	10322	2721	50
Combined max.	kg	40823		23151			
Volume	m ³	94		90.6		16.99	0.04
Number of units		2C/2P	5P	12C	4C/1P		

Note: Max. weight per pallet 88 x 125" is 4625 kg, for pallet 96 x 125" 5100 kg.
Variable pallet, container configuration.

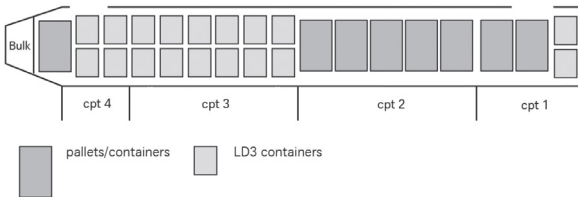

Basic allocation for cargo and mail

8 pallets/containers

10 LD3 containers

Fleet

Airbus A340-300 (343)

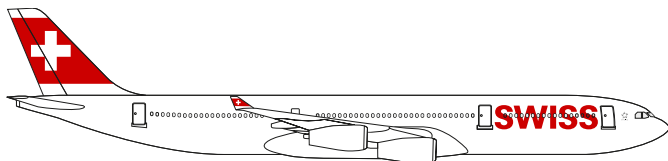

Area of operation

North and South America, Africa, Middle East, Asia

Capacity for cargo and mail

Up to 22 tons with full passenger load

Weight and volume limitations

Compartments		1	2	3	4	5 Bulk	Security locker
Capacity	kg	10206	20412	14832	11619	1881	7
Combined max.	kg	22861		18507			
Volume	m ³	80.5		62.5		12.0	0.04
Number of units		6 C	4 P	6 C 1 P	7 C		

Note: Max. weight per pallet 88 × 125" is 4625 kg, for pallet 96 × 125" 5100 kg.

Section 52 is occupied by an additional container position (44L).

Variable pallet, container configuration.

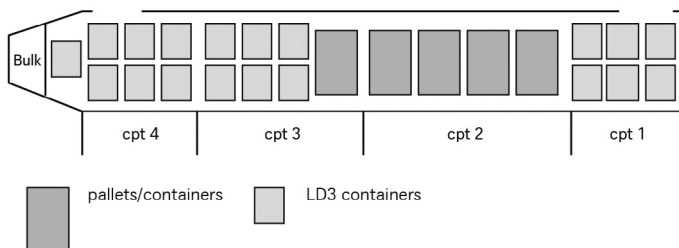

Basic allocation for cargo and mail

5 pallets/containers

10 LD3 containers

Fleet

Airbus A330-300 (333)

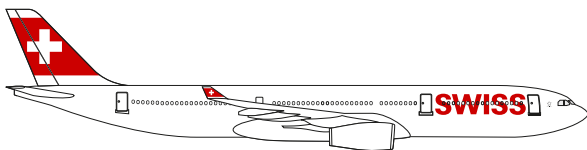

Area of operation

North America, Asia, Africa, Middle East

Capacity for cargo and mail

Up to 19 tons with full passenger load

Weight and volume limitations

Compartments		1	2	3	4	5 Bulk	Security locker
Capacity	kg	9522	20412	14832	10206	3408	50
Combined max.	kg	22861		18507			
Volume	m ³	80.5		62.6		19.6	0.09
Number of units		2 P or 6 C	4 P or 12 C	3 P or 8 C	2 P or 6 C		

Note: Max. weight per pallet 88 × 125" is 4625 kg, for pallet 96 × 125" 5100 kg.
Variable pallet, container configuration.

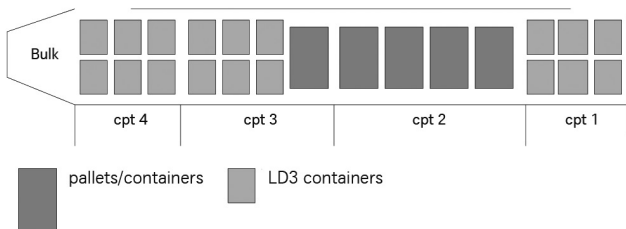

Basic allocation for cargo and mail

5 pallets/containers

10 LD3 containers

Fleet

Airbus A321-111 (321)

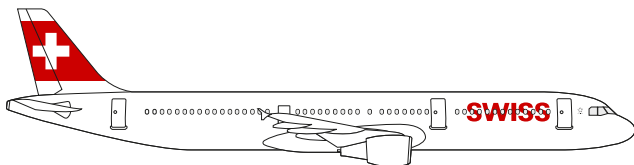

Area of operation

Europe, North Africa, Middle East

Capacity for cargo and mail

Up to 2.8 tons with full passenger load

Weight and volume limitations

Compartments		1	2	3	4	5 Bulk	Security locker
Capacity	kg	2268	3402	3402	2268	1377	30
Volume	m ³	7.0	10.5	10.5	7.0	5.2	0.036
Number of units		2 C	3 C	3 C	2C		

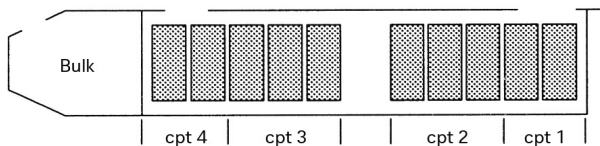

LD3-45 containers

Basic allocation for cargo and mail

4 containers

Fleet

Airbus A321neo (32Q)

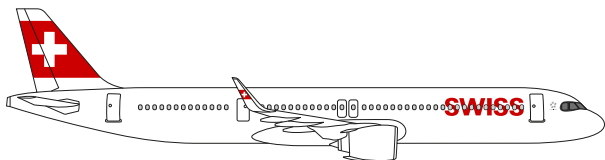

Area of operation

Europe, North Africa, Middle East

Capacity for cargo and mail

Up to 2.8 tons with full passenger load

Weight and volume limitations

Compartments		1	2	3	4	5 Bulk	Security locker
Capacity	kg	2268	3402	3402	2268	1377	18
Volume	m ³	7.0	10.5	10.5	7.0	5.2	0.035
Number of units		2 C	3 C	3 C	2C		

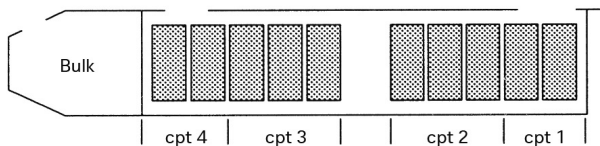

LD3-45 containers

Basic allocation for cargo and mail

4 containers

Fleet

Airbus A320-214 (320)

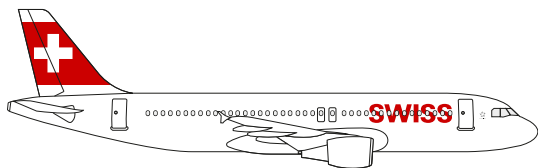

Area of operation

Europe, North Africa, Middle East

Capacity for cargo and mail

Up to 2.4 tons with full passenger load

Weight and volume limitations

Compartments		1	3	4	5 Bulk	Security locker
Capacity	kg	3402	2268	2268	500*	30
Volume	m ³	10.5	7.0	7.0	2.5*	0.09
Number of units		3 C	2 C	2 C		

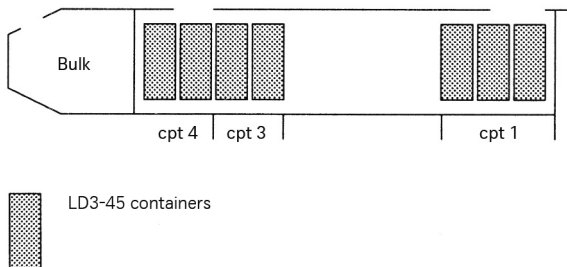

Basic allocation for cargo and mail

2 containers

* Of which max 100 kg/0.5 m³ for cargo and mail

Fleet

Airbus A320neo (32N)

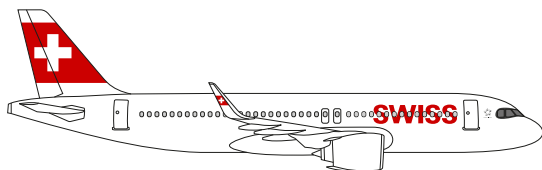

Area of operation

Europe, North Africa, Middle East

Capacity for cargo and mail

Up to 2.4 tons with full passenger load

Weight and volume limitations

Compartments		1	3	4	5 Bulk	Security locker
Capacity	kg	3402	2268	2268	500*	30
Volume	m ³	10.5	7.0	7.0	2.5*	0.09
Number of units		3 C	2 C	2 C		

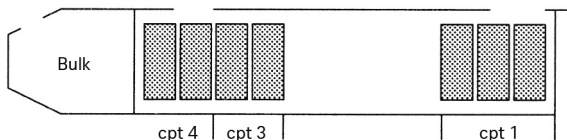

LD3-45 containers

Basic allocation for cargo and mail

2 containers

* Of which max 100 kg/0.5 m³ for cargo and mail

Fleet

Airbus A220-100 (221)

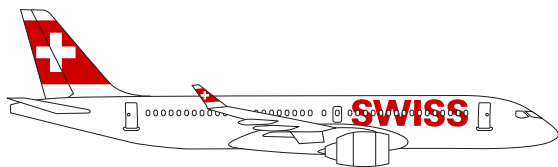

Area of operation

Europe

Capacity for cargo and mail

Up to 3 tons

Weight and volume limitations

		Compartment 1	Compartment 4
Maximum mass	kg	1697	2063
Maximum combined load	kg	3760	
Volume	m ³	8.81	11.69
Max. specific load (flat floor)	kg/m ²	732	732
Max. specific load (curved floor)	kg/m ²	293	293

Security locker available: 320 x 400 x 350 (mm)

Maximum weight of a single piece: 149 kg

Fleet

Airbus A220-100 (221)

Maximum dimensions of packages

Forward Cargo Compartment

	Length (cm)														
80	248	233	223	210	203	193	185	177	172	165	157				
78	274	256	243	231	220	210	200	193	185	177	172				
76	294	276	259	246	233	223	213	203	195	187	180				
73	317	297	279	264	248	236	226	215	208	200	193				
68	363	337	314	294	276	264	251	238	228	218	210	203	195		
63	370	370	350	325	304	287	271	259	248	236	228	218	210		
58	370	370	370	355	332	312	294	279	264	254	243	233	223		
50	370	370	370	370	370	345	322	302	287	271	261	248	238		
30	370	370	370	370	370	370	355	332	312	297	281	269	256		
	7	15	22	30	38	45	53	60	68	76	83	91	99		
	Width (cm)														

Aft Cargo Compartment - Forward Section

	Length (cm)														
80	248	233	223	210	203	193	185	177	172	165	157				
78	274	256	243	231	220	210	200	193	185	177	172				
76	294	276	259	246	233	223	213	203	195	187	180				
73	317	297	279	264	248	236	226	215	208	200	193				
68	322	322	314	294	276	264	251	238	228	218	210	203	195		
63	322	322	322	322	304	287	271	259	248	236	228	218	210		
58	322	322	322	322	322	312	294	279	264	254	243	233	223		
50	322	322	322	322	322	322	322	302	287	271	261	248	238		
30	322	322	322	322	322	322	322	322	312	297	281	269	256		
	7	15	22	30	38	45	53	60	68	76	83	91	99		
	Width (cm)														

Aft Cargo Compartment - Aft Section

	Length (cm)														
80	241	231	218	208	198	193	185	177	172	165	157				
78	266	251	241	228	215	208	200	193	185	177	172				
76	281	269	254	243	231	220	210	200	195	187	180				
73	304	284	271	256	243	233	223	213	205	200	193				
68	345	320	302	284	271	256	243	236	226	215	208	200	195		
63	388	355	332	314	294	281	266	254	241	233	226	215	208		
58	406	396	363	340	322	302	284	271	259	246	238	231	220		
50	406	406	406	381	355	330	312	294	281	266	254	243	236		
30	406	406	406	406	396	365	342	322	304	287	276	261	251		
	7	15	22	30	38	45	53	60	68	76	83	91	99		
	Width (cm)														

Fleet

Airbus A220-300 (223)

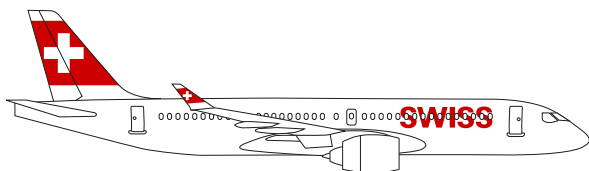

Area of operation

Europe

Capacity for cargo and mail

Up to 5 tons

Weight and volume limitations

		Compartment 1	Compartment 4
Maximum mass	kg	2446	2606
Maximum combined load	kg	5052	
Volume	m ³	13.08	14.92
Max. specific load (flat floor)	kg/m ²	732	732
Max. specific load (curved floor)	kg/m ²	293	293

Security locker available: 363 x 457 x 348 (mm)

Maximum weight of a single piece: 149 kg

Aircraft specification applicable as well for wet lease operation of airBaltic.

Fleet

Airbus A220-300 (223)

Maximum dimensions of packages

Forward Cargo Compartment

Length (cm)													
80	248	233	223	210	203	193	185	177	172	165	157		
78	274	256	243	231	220	210	200	193	185	177	172		
76	294	276	259	246	233	223	213	203	195	187	180		
73	317	297	279	264	248	236	226	215	208	200	193		
68	363	337	314	294	276	264	251	238	228	218	210	203	195
63	411	378	350	325	304	287	271	259	248	236	228	218	210
58	462	419	386	355	332	312	294	279	264	254	243	233	223
50	541	482	436	401	370	345	322	302	287	271	261	248	238
30	584	568	505	457	416	383	355	332	312	297	281	269	256
	7	15	22	30	38	45	53	60	68	76	83	91	99
Width (cm)													

Aft Cargo Compartment - Forward Section

Length (cm)													
80	248	233	223	210	203	193	185	177	172	165	157		
78	274	256	243	231	220	210	200	193	185	177	172		
76	294	276	259	246	233	223	213	203	195	187	180		
73	317	297	279	264	248	236	226	215	208	200	193		
68	363	337	314	294	276	264	251	238	228	218	210	203	195
63	411	378	350	325	304	287	271	259	248	236	228	218	210
58	462	419	386	355	332	312	294	279	264	254	243	233	223
50	482	482	436	401	370	345	322	302	287	271	261	248	238
30	482	482	482	457	416	383	355	332	312	297	281	269	256
	7	15	22	30	38	45	53	60	68	76	83	91	99
Width (cm)													

Aft Cargo Compartment - Aft Section

Length (cm)													
80	241	231	218	208	198	193	185	177	172	165	157		
78	266	251	241	228	215	208	200	193	185	177	172		
76	281	269	254	243	231	220	210	200	195	187	180		
73	304	284	271	256	243	233	223	213	205	200	193		
68	345	320	302	284	271	256	243	236	226	215	208	200	195
63	388	355	332	314	294	281	266	254	241	233	226	215	208
58	406	396	363	340	322	302	284	271	259	246	238	231	220
50	406	406	406	381	355	330	312	294	281	266	254	243	236
30	406	406	406	406	396	365	342	322	304	287	276	261	251
	7	15	22	30	38	45	53	60	68	76	83	91	99
Width (cm)													

Fleet

Embraer 190 (E90)

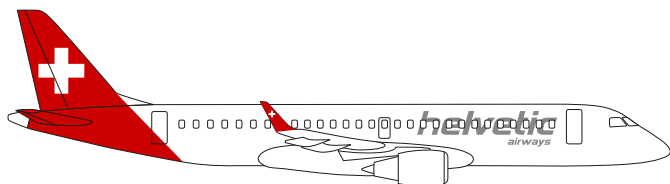

Area of operation

Europe

Capacity for cargo and mail

Up to 3.5 tons

(High passenger and luggage load substantially reduce the cargo/mail uplift.)

Weight and volume limitations

		FWD Compartment	AFT Compartment
Maximum weight	kg	1696	1401
Usable Volume	m ³	10.99	8.92
Maximum floor load	kg/m ²	488	488

Security locker not available.

Maximum weight of a single piece: 149 kg

Fleet

Embraer 190 (E90)

Maximum dimensions of packages

Forward Cargo Compartment

		Maximum Package Length (cm)							
Height (cm)	71	302	250	215	150	140	140	130	120
	63	344	256	221	180	170	150	130	130
	56	483	396	294	215	180	170	150	130
	48	495	400	300	270	240	210	170	150
	40	500	410	310	280	240	210	190	160
	33	505	416	340	280	260	230	200	170
	25	510	448	348	290	260	230	200	170
	20	516	453	354	290	280	240	220	200
	13	570	570	366	311	280	270	220	200
		13	25	38	51	63	76	89	101
			Width (cm)						

Aft Cargo Compartment

		Maximum Package Length (cm)							
Height (cm)	56	400	340	270	230	200	195	145	145
	48	450	340	280	235	200	195	150	145
	40	450	340	280	240	210	200	155	145
	33	460	350	290	257	210	200	163	159
	25	470	360	320	260	230	210	170	162
	20	470	380	340	319	250	230	190	179
	13	470	450	420	380	350	300	250	210
		13	25	38	51	63	76	89	101
			Width (cm)						

Fleet

Embraer 190-E2 (290)

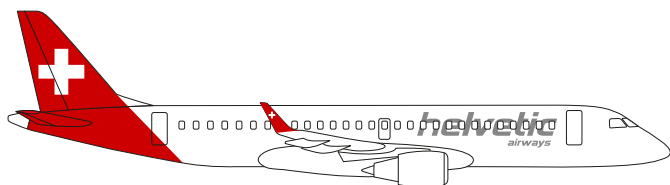

Area of operation

Europe

Capacity for cargo and mail

Up to 3.5 tons

(High passenger and luggage load substantially reduce the cargo/mail uplift.)

Weight and volume limitations

		FWD Compartment	AFT Compartment
Maximum weight	kg	1590	1910
Usable Volume	m ³	8.75	10.07
Maximum floor load	kg/m ²	488	488

Security locker not available.

Maximum weight of a single piece: 149 kg

Fleet

Embraer 190-E2 (290)

Maximum dimensions of packages

Forward Cargo Compartment

		Maximum Package Length (cm)							
		71	63	56	48	40	33	25	20
Height (cm)		302	250	215	150	140	140	130	120
		344	256	221	180	170	150	130	130
		483	396	294	215	180	170	150	130
		495	400	300	270	240	210	170	150
		500	410	310	280	240	210	190	160
		505	416	340	280	260	230	200	170
		510	448	348	290	260	230	200	170
		516	453	354	290	280	240	220	200
		570	570	366	311	280	270	220	200
		13	25	38	51	63	76	89	101
		Width (cm)							

Aft Cargo Compartment

		Maximum Package Length (cm)								
		56	48	40	33	25	20	13	13	
Height (cm)		400	340	270	230	200	195	145	145	
		450	340	280	235	200	195	150	145	
		450	340	280	240	210	200	155	145	
		460	350	290	257	210	200	163	159	
		470	360	320	260	230	210	170	162	
		470	380	340	319	250	230	190	179	
		470	450	420	380	350	300	250	210	
		13	25	38	51	63	76	89	101	
			Width (cm)							

Fleet

Embraer 195-E2 (295)

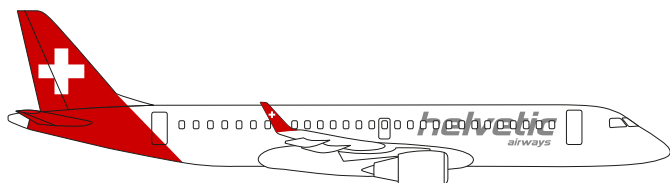

Area of operation

Europe

Capacity for cargo and mail

Up to 3.5 tons

(High passenger and luggage load substantially reduce the cargo/mail uplift.)

Weight and volume limitations

		FWD Compartment	AFT Compartment
Maximum weight	kg	1590	1910
Usable Volume	m ³	8.75	10.07
Maximum floor load	kg/m ²	488	488

Security locker not available.

Maximum weight of a single piece: 149 kg

Fleet

Embraer 195-E2 (295)

Maximum dimensions of packages

Forward Cargo Compartment

		Maximum Package Length (cm)							
		71	302	250	215	150	140	140	130
Height (cm)	63	344	256	221	180	170	150	130	130
	56	483	396	294	215	180	170	150	130
	48	495	400	300	270	240	210	170	150
	40	500	410	310	280	240	210	190	160
	33	505	416	340	280	260	230	200	170
	25	510	448	348	290	260	230	200	170
	20	516	453	354	290	280	240	220	200
	13	570	570	366	311	280	270	220	200
		13	25	38	51	63	76	89	101
			Width (cm)						

Aft Cargo Compartment

		Maximum Package Length (cm)								
		56	400	340	270	230	200	195	145	145
Height (cm)	48	450	340	280	235	200	195	150	145	
	40	450	340	280	240	210	200	155	145	
	33	460	350	290	257	210	200	163	159	
	25	470	360	320	260	230	210	170	162	
	20	470	380	340	319	250	230	190	179	
	13	470	450	420	380	350	300	250	210	
		13	25	38	51	63	76	89	101	
			Width (cm)							

Fleet

Edelweiss Airbus A320-214 (32E)



Area of operation

Europe, North Africa, Middle East

Weight and volume limitations

Compartments		1	3	4	5
Capacity	kg	3402	2426	2110	1497
Volume	m ³	13.2	9.7	8.5	5.8
Total Capacity	9435 kg / 37.2 cm				
Max Floor Load	732 kg/m ²				

Loading possibilities

Max weight per piece	149 kg
ULD	Not Allowed
FREE LOAD	OK
BIG	See Charts
HEA	Need OK from CSD

Compartment 1

Width cm	0	10	20	30	40	50	60	70	80	90	100	110	120	130	140	150	160	164
Heightrange 1-115 cm	435	415	395	375	355	335	315	294	247	254	234	214	194	173	165	143	143	143
Heightrange 1-97cm	475	475	475	455	435	414	394	374	354	334	314	294	273	253	233	212	200	200
Heightrange 1-70 cm	475	475	475	475	475	475	465	333	424	403	382	362	341	319	298	275	253	253
Package Length in cm																		

Compartment 3 & 4

Width cm	0	10	20	30	40	50	60	70	80	90	100	110	120	130	140	150	160	171
Heightrange 1-115 cm	444	424	404	384	364	344	324	304	284	264	243	223	203	182	172	143	143	143
Heightrange 1-97cm	485	485	485	465	445	425	405	384	364	344	324	304	284	264	243	223	202	200
Heightrange 1-70 cm	485	485	485	485	485	485	475	355	435	414	394	373	352	331	310	288	266	253
Package Length in cm																		

Unit Load Devices (ULD)

Overview

ULD description (external dimensions in inches)	IATA code	Interior dimensions (length/width/height in cm)	Usable volume m ³ cu. ft	Maximum gross weight kg lbs	Interchangeability		
					333/343/77W	320/321	Selected truck routes

Pallets

96 inch	P6P PMC	304x230x160	11.4 401	5103 11250	X		X
88 inch	P1P PAJ	304x210x160	10.3 366	4626 10198	X		X
LD11	PLA PLB	304x139x160	6.5 231	3175 7000	X		X
60.4 inch* (PKC)	PKC	145x143x114	2.1 73	1134 2500		X	X

Containers

LD9	AMP	305x223x154	10.5 371	5103 11250	X		X
LD3	AKE	146x144x153	4.3 152	1587 3500	X		X
	AVA				X		X
LD3-45	AKH	145x143x111	3.6 127	1134 2500		X	X
LD3-45 (Valuable cargo)	AKW	145x143x111	3.6 127	1134 2500		X	X

* Through unit acceptable only within A320 family.

Unit Load Devices (ULD)

Overview

ULD description	IATA code	Interior dimensions (length/width/height in cm)	Usable volume m ³ cu. ft	Maximum gross weight kg lbs	Interchangeability		
					333/343/77W	320/321	Selected truck routes

Envirotainer ICE cooling system

LD9	RAP (t2)	253x206x142	8.22 290.2	4626 10198 (incl. dry ice)	X		X
LD3	RKN (t2)	141x135x136	2.93 103.4	1587 3500 (incl. dry ice)	X		X

Sonoco ThermoSafe Advanced Passive Temperature-Controlled ULD

LD3	AKP	122x102x122	1.5	1587 3500	X		X
-----	-----	-------------	-----	--------------	---	--	---

Envirotainer electric compressor cooling system

LD9	RAP (e2)	246x205x126	6.38 224.2	4626 10198	X		X
LD9	RAP (Releye)	246x205x132	6.60 233	4625 10196	X		X
LD11	RLP (Releye)	247x135x132	4.4 156	3175 6999	X		X
LD3	RKN (e1)	134x132x131	2.3 81.9	1587 3500	X		X

CSafe

LD9	RAP	130x248x208	6.68 236	4626 10198	X		X
LD3	RKN	122x127x128	1.9 70	1587 3500	X		X

DoKaSch

LD9	RAP	246x202x132	6.57 232	4626 10198	X		X
LD3	RKN	126x130x122	1.8 66	1587 3500	X		X

Swiss Airtainer

LD3	RKN	137x130x132	2.4 84.7	1587 3500	X		X
-----	-----	-------------	-------------	--------------	---	--	---

Unit Load Devices (ULD)

Detailed information

Remark

All figures are interior dimensions. The actual maximum net weight of each container depends on the structural weight limitations of the respective loading position in the aircraft.

96 inch pallet

IATA code:	PMC
Loadable:	333 / 343 / 77W
Usable loading area:	304 x 230 cm / 120 x 91 in
Max. height:	160 cm / 63 in
Tare weight:	110 kg / 242 lbs
Max. gross weight:	5103 kg / 11250 lbs

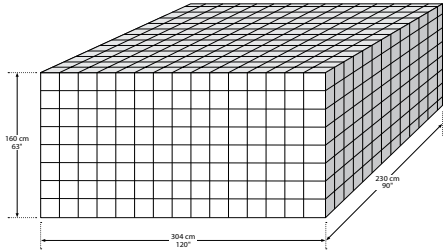

88 inch pallet

IATA code:	PAJ
Loadable:	333 / 343 / 77W
Usable loading area:	304 x 210 cm / 120 x 83 in
Max. height:	160 cm / 63 in
Tare weight:	110 kg / 242 lbs
Max. gross weight:	4626 kg / 10198 lbs

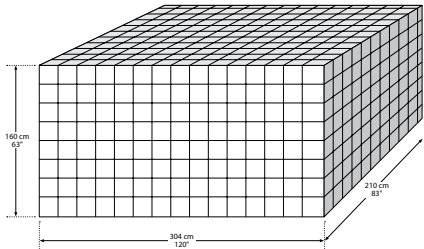

Weights depend on the structural weight limitations of the different pallet/container positions in the aircraft.
Could be built higher, if route is truck operated only.

Unit Load Devices (ULD)

Detailed information

LD11 pallet

IATA code:	PLA / PLB
Loadable:	333 / 343 / 77W
Usable loading area:	304 x 139 cm / 120 x 55 in
Max. height:	160 cm / 63 in
Tare weight:	90-116 kg / 198-255 lbs
Max. gross weight:	3175 kg / 7000 lbs

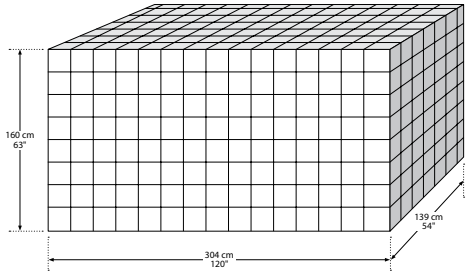

60.4 inch pallet

IATA code:	PKC
Loadable:	320 / 321
Usable loading area:	145 x 143 cm / 57 x 56 in
Max. height:	114 cm / 45 in
Tare weight:	40 kg / 88 lbs
Max. gross weight:	1134 kg / 2500 lbs

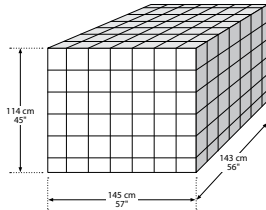

Could be built higher, if route is truck operated only.

Unit Load Devices (ULD)

Detailed information

LD9 container

IATA code:	AMP
Loadable:	333 / 343 / 77W
Usable loading area:	305 x 223 cm / 120 x 88 in
Max. height:	154 cm / 61 in
Tare weight:	270 kg / 595 lbs
Max. gross weight:	5103 kg / 11250 lbs

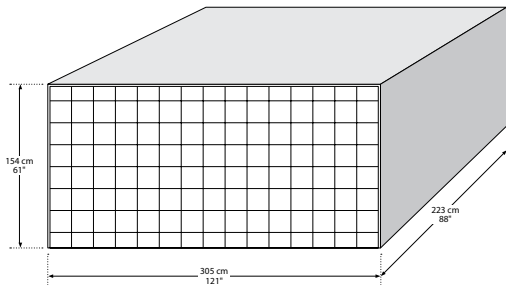

LD3 container

IATA code:	AKE
Loadable:	333 / 343 / 77W
Usable loading area:	146 x 144 cm / 57 x 57 in
Max. height:	153 cm / 60 in
Top length:	193 cm / 76 in
Tare weight:	66-88 kg / 145-194 lbs
Max. gross weight:	1587 kg / 3500 lbs

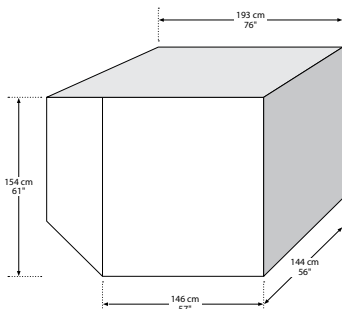

Weights depend on the structural weight limitations of the different pallet/container positions in the aircraft.

Unit Load Devices (ULD)

Detailed information

LD3-45 container

IATA code:	AKH
Loadable:	320 / 321
Usable loading area:	145 x 143 cm / 57 x 56 in
Max. height:	111 cm / 44 in
Top Length:	243 cm / 96 in
Tare weight:	82 kg / 180 lbs
Max. gross weight:	1134 kg / 2500 lbs

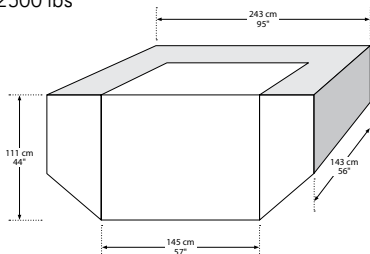

LD3-45 container valuable cargo

IATA code:	AKW
Loadable:	320 / 321
Usable loading area:	145 x 143 cm / 57 x 56 in
Max. height:	100 cm / 39 in
Top Length:	243 cm / 96 in
Tare weight:	100 kg / 220 lbs
Max. gross weight:	1134 kg / 2500 lbs

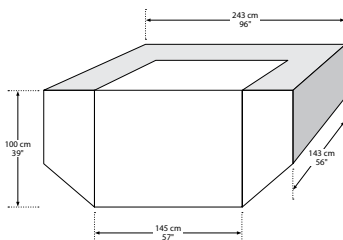

Cooling Unit Load Devices

Detailed information

LD9 Envirotainer RAP t2

IATA code:	RAP
Loadable:	333 / 343 / 77W
Usable loading area:	253 x 206 cm / 100 x 81 in
Max. height:	142 cm / 56 in
Tare weight:	450 kg / 992 lbs
Max. gross weight:	4626 kg / 10198 lbs
Dry ice capacity:	300 kg 660 lbs
Temperature range:	-20 °C to +20 °C -4 °F to +68 °F

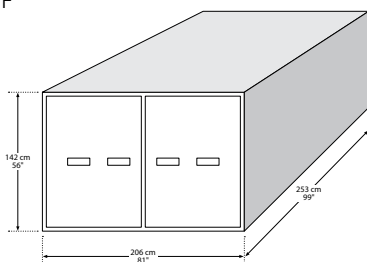

LD3 Envirotainer RKN t2

IATA code:	RKN
Loadable:	333 / 343 / 77W
Usable loading area:	141 x 135 cm / 56 x 53 in
Max. height:	136 cm / 53 in
Tare weight:	265 kg / 584 lbs
Max. gross weight:	1587 kg / 3500 lbs
Dry ice capacity:	180 kg 397 lbs
Temperature range:	-20 °C to +20 °C -4 °F to +68 °F

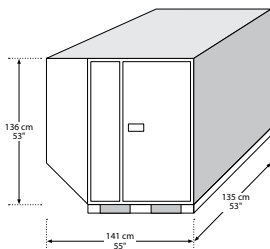

Cooling Unit Load Devices

Detailed information

LD9 Envirotainer RAP e2

IATA code:	RAP
Loadable:	333 / 343 / 77W / truck
Usable loading area:	246 x 205 cm / 97 x 80 in
Max. height:	126 cm / 49 in
Tare weight:	1100 kg / 2425 lbs
Max. gross weight:	4626 kg / 10198 lbs
Recharging power supply:	100-240 V AC, 50-60 Hz
Maximum power consumption:	1850 W
Maximum charging time:	12 h
Temperature range:	0 °C to +25 °C +32 °F to +77 °F

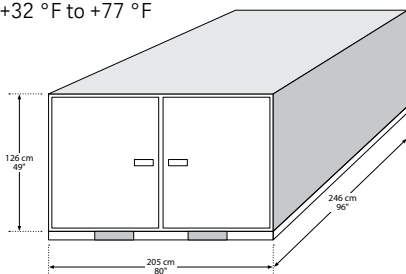

LD9 Envirotainer Releye RAP

IATA code:	RAP
Loadable:	333 / 343 / 77W / truck
Usable loading area:	246 x 205 cm / 97 x 80 in
Max. height:	132 cm / 52 in
Tare weight:	1100 kg / 2425 lbs
Max. gross weight:	4625 kg / 10196 lbs
Recharging power supply:	100-240 V AC, 50-60 Hz
Maximum power consumption:	1850 W
Maximum charging time:	11 h
Temperature range:	+5 °C and +20 °C +41 °F and +68 °F

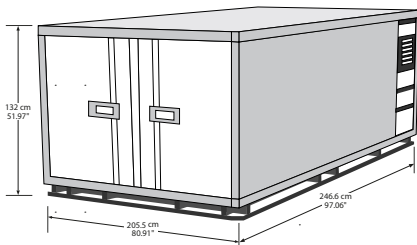

Cooling Unit Load Devices

Detailed information

LD11 Envirotainer Releye RLP

IATA code:	RLP
Loadable:	333 / 343 / 77W / truck
Usable loading area:	247 x 135 cm / 97 x 55 in
Max. height:	132 cm / 52 in
Tare weight:	880 kg / 1940 lbs
Max. gross weight:	3175 kg / 6999 lbs
Recharging power supply:	100-240 V AC, 50-60 Hz
Maximum charging time:	11 h
Temperature range:	+5 °C and +20 °C +41 °F and +68 °F

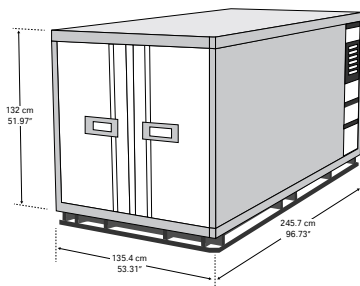

LD3 Envirotainer RKN e1

IATA code:	RKN
Loadable:	333 / 343 / 77W / truck
Usable loading area:	134 x 132 cm / 52 x 51 in
Max. height:	131 cm / 51 in
Tare weight:	635 kg / 1399 lbs
Max. gross weight:	1587 kg / 3500 lbs
Recharging power supply:	100-240 V AC, 50-60 Hz
Maximum power consumption:	1850 W
Maximum charging time:	8 h
Temperature range:	0 °C to +20 °C +32 °F to +68 °F

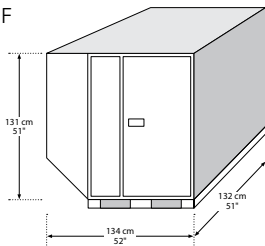

Cooling Unit Load Devices

Detailed information

LD3 Sonoco ThermoSafe, Pegasus

IATA code:	AKP
Loadable:	333 / 343 / 77W / truck
Usable loading area:	122 x 102 cm / 48 x 40 in
Max. height:	122 cm / 48 in
Tare weight:	616 kg / 1358 lbs
Max. gross weight:	1588 kg / 3500 lbs
Temperature range:	+2 °C to +8 °C +36 °F to +46 °F

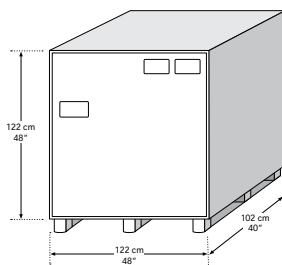

Cooling Unit Load Devices

Detailed information

LD9 CSafe RAP

IATA code:	RAP
Loadable:	333 / 343 / 77W / truck
Usable loading area:	248 x 208 cm / 98 x 82 in
Max. height:	130 cm / 51 in
Tare weight:	1213 kg / 2675 lbs
Max. gross weight:	4626 kg / 10198 lbs
Recharging power supply:	100-240 V AC, 50-60 Hz
Maximum charging time:	approx. 10 h
Temperature range:	+4 °C to +25 °C +39 °F to +77 °F

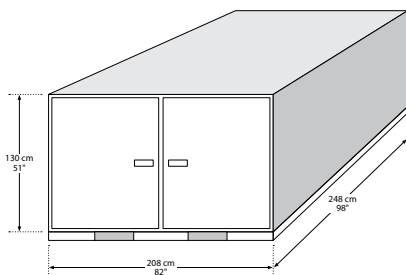

LD3 CSafe RKN

IATA code:	RKN
Loadable:	333 / 343 / 77W / truck
Usable loading area:	121 x 127 cm / 47 x 50 in
Max. height:	127 cm / 50 in
Tare weight:	646 kg / 1424 lbs
Max. gross weight:	1587 kg / 3500 lbs
Recharging power supply:	100-240 V AC, 50-60 Hz
Maximum charging time:	approx. 6 h
Temperature range:	+4 °C to +25 °C +39 °F to +77 °F

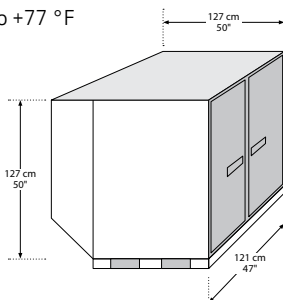

Cooling Unit Load Devices

Detailed information

LD9 DoKaSch RAP

IATA code:	RAP
Loadable:	333 / 343 / 77W / truck
Usable loading area:	246 x 202 cm / 97 x 79 in
Max. height:	132 cm / 52 in
Tare weight:	1140 kg / 2513 lbs
Max. gross weight:	4626 kg / 10198 lbs
Recharging power supply:	110-220 V AC, 50-60 Hz (special cables needed)
Maximum charging time:	approx. 6 h
Temperature range:	+2 °C to +30 °C +36 °F to +86 °F

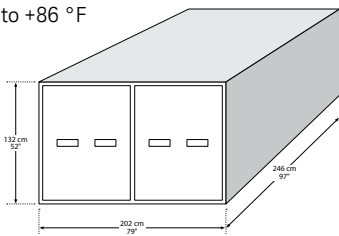

LD3 DoKaSch RKN

IATA code:	RKN
Loadable:	333 / 343 / 77W / truck
Usable loading area:	126 x 130 cm / 49 x 51 in
Max. height:	122 cm / 48 in
Tare weight:	670 kg / 1477 lbs
Max. gross weight:	1587 kg / 3500 lbs
Recharging power supply:	110-220 V AC, 50-60 Hz (special cables needed)
Maximum charging time:	approx. 6 h
Temperature range:	+2 °C to +30 °C +36 °F to +86 °F

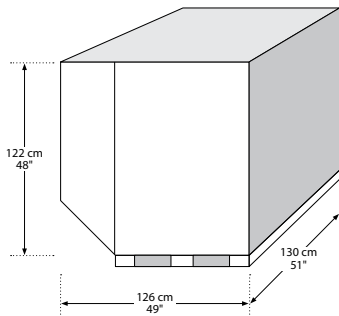

Cooling Unit Load Devices

Detailed information

LD3 Swiss Airtainer

IATA code:	RKN
Loadable:	333 / 343 / 77W / truck
Usable loading area:	137 x 130 x 132 cm
Max. height:	132 cm
Tare weight:	390 kg / 859 lbs
Max. gross weight:	1587 kg / 3500 lbs

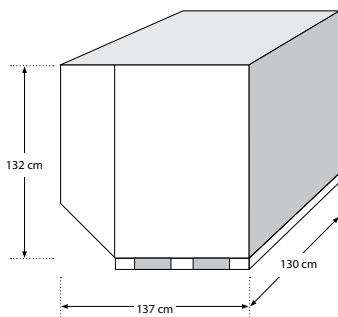

Packagings

Detailed information

va-Q-case Half Euro (only on request)

IATA code:	JYP6
Loadable:	320 / 321 / 333 / 343 / 77W / truck
Usable loading area:	60 x 34 cm / 23 x 13 in
Max. height:	47 cm / 18 in
Tare weight:	113 kg / 249 lbs

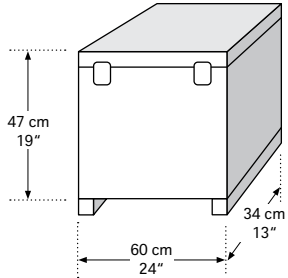

va-Q-tainer Eurox

IATA code:	JYP5
Loadable:	333 / 343 / 77W / truck
Usable loading area:	120 x 85 cm / 47 x 33 in
Max. height:	117 cm / 46 in
Tare weight:	440 kg / 970 lbs

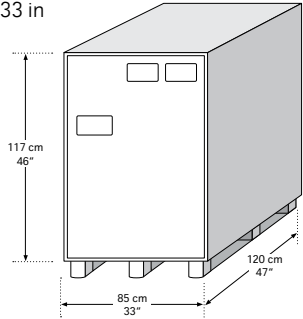

va-Q-tainer USx

IATA code:	JYP4
Loadable:	333 / 343 / 77W / truck
Usable loading area:	120 x 125 cm / 47 x 49 in
Max. height:	117 cm / 46 in
Tare weight:	578 kg / 1274 lbs

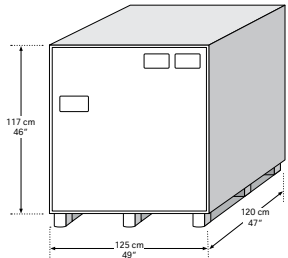

Packagings

Detailed information

19.va-Q-tainer XLx

IATA code:	JYP3
Loadable:	333 / 343 / 77W / truck
Usable loading area:	164 x 125 cm / 64 x 49 in
Max. height:	122 cm / 48 in
Tare weight:	660 kg / 1455 lbs

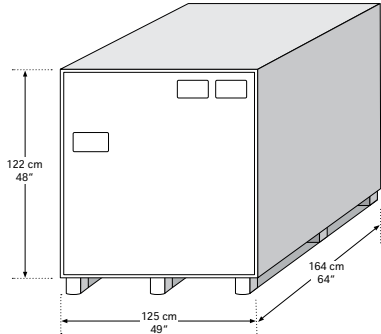

va-Q-tainer TwinX

IATA code:	JYP3
Loadable:	333 / 343 / 77W / truck
Usable loading area:	211 x 125 cm / 83 x 49 in
Max. height:	122 cm / 48 in
Tare weight:	800 kg / 1763 lbs

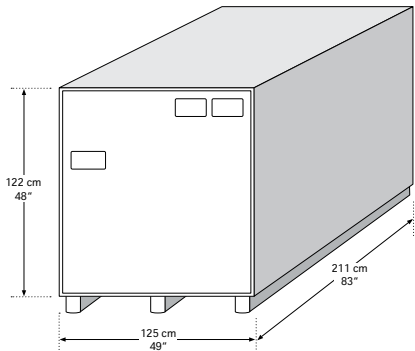

Insurance

General information

Remark

Swiss International Air Lines Ltd.'s door-to-door cargo insurance (summary – terms and conditions of the insurance are subject to change without prior notice).

Introduction

We do of course our utmost to deliver your shipment safely and in time to its destination. In spite of the best care given, goods may get stolen, lost or damaged in transit, we therefore recommend you to insure your cargo against such risks. For this purpose, SWISS holds an open cover with Delvag Versicherungs-AG, Venloer Strasse 151-153, 50672 Cologne Germany.

Insurable value

The insurable value corresponds to the value of the goods at the place and time of commencement of the insured voyage, plus freight, insurance and other charges incurred up to the place of destination. In respect of trade goods, the value thus determined may be increased by the buyer's expected profit not exceeding 10% unless otherwise agreed. If there are no trade goods involved, the material cost, together with freight and the insurance premium, may be insured. Customs and excise duty may also be insured by special agreement.

Maximum sum insured

The maximum sum that can be insured for any one consignment is CHF 1 000 000 or the equivalent in foreign currency. For watches, jewellery, genuine pearls (including culture pearls), precious stones and other jewels as well as mobile phones different conditions apply, which can be requested at: cargo.claims@swiss.com or aircargo@delvag.de. The maximum sum insured may be increased by special agreement prior to the commencement of the risk.

To arrange insurance in excess of the above maxima, contact Swiss World-Cargo, Claims Management, P.O. Box ZRHS/LB-OS, CH-8058 Zurich Airport, cargo.claims@swiss.com or aircargo@delvag.de. Allow time to consult the insurers/re-insurers of at least 3 working days.

Insurance

Goods of all kinds

Insurance cover goods of all kinds

Air cargo shipments of any kind may be insured on a worldwide basis via the SWISS Air Waybill within the terms and conditions of the open policy concluded between SWISS and Delvag. For species (valuable goods) as per insurer's definition see "Insurance cover species (valuables)" below.

Scope of insurance

The insurance is against all risks of damage or loss as per the special conditions of the open cover for goods.

Watches, jewellery, genuine pearls (including culture pearls), precious stones and other jewels: during the time the goods are in the custody of the assured, consignor or consignee, except in those cases where they are acting in the capacity of a carrier, the insurer is liable for loss only if it is the direct consequence of one of the following events:

violence threatened or used against the person charged with effecting the carriage or inability of those persons to offer resistance as a result of accident or death, specified accident in accordance with the general conditions. During intermediate stops: burglary occurring in locked rooms of massive buildings.

Livestock, perishable goods (plants, fruits, flowers, blood plasma, vaccines, meat, pharmaceutical, chemical, etc.), removal goods and vehicles have a special cover, please inquire with Swiss WorldCargo, Claims Management, P.O. Box ZRHS/LB-OS, CH-8058 Zurich Airport, cargo.claims@swiss.com.

Unless otherwise agreed, war, strike, disturbances and terrorism risks are not included.

Duration of insurance

The insurance is operative from warehouse to warehouse. It begins when the goods are delivered to the transporters (forwarding agents, post office, railway, airline) or their agents and sub-carriers, and terminates on delivery to the consignee named in the air waybill or insurance certificate, or to the final consignee designated by same.

For shipments of goods, collection from or delivery to the airports is covered, even when undertaken by the consignee or consignor.

Notwithstanding anything to the contrary contained elsewhere in the summary mobile phones are only covered from airport to airport by air.

Insurance

Goods of all kinds

Note:

Transport to the airport of departure is only insured on condition that a specific request to this effect is made to LX or an IATA agent before commencement of the risk (i.e. on advice of shipment).

Delays in the execution of the insured voyages is limited to 60 days any one delay.

Security measures (surface)

For goods with high values (watches, jewellery, precious stones, etc.) adequate security measures must be provided for transportation from shipper's domicile to the airport of departure and from the airport of destination to the consignee's domicile.

Forwarding instruction (air)

Each consignment by aircraft with a value of CHF 10 000.– or higher each kilogramme gross has to be forwarded as "Valuable Cargo".

Watches, jewellery, genuine pearls (including culture pearls), precious stones and other jewels: each package by aircraft with a value of CHF 25 000.– or higher has to be forwarded as "Valuable Cargo".

Mobile phones: each consignment by aircraft has to be sent as SWISS Argus. If SWISS Argus is not available for a certain destination the consignment has to be forwarded as "Valuable Cargo". Forwarding as "Valuable Cargo" has also to be complied with if the value per each package by aircraft is in excess of CHF 25 000.– or if the value of the consignment by aircraft is in excess of CHF 200 000.–.

Insurance premium

The premium is calculated on the basis of the insurance value. The minimum per insured consignment is CHF 20.– or the equivalent in other currencies.

Insurance zones

Zone 1: Europe, including European part of Turkey

Zone 2: North America, including Mexico

Zone 3: Central and South America

Zone 4: Africa

Zone 5: Asia, including Asian part of Turkey /
Middle East / Australia and Oceania

Insurance

Goods of all kinds

Tariff "goods of all kinds"

Zone	1	2	3	4	5
	‰	‰	‰	‰	‰
1	1.0	1.5	3.0	2.5	2.5
2	1.5	1.0	3.0	2.5	2.5
3	3.0	3.0	2.5	3.0	3.0
4	2.5	2.5	3.0	2.5	2.5
5	2.5	2.5	3.0	2.5	2.0

‰ per mille of the insurable value

Special premiums for all routes

- Removal goods and personal effects (shipped as cargo) 9.00‰
- Fragile and delicate goods (glass, porcelain, stoneware, sculptures, glassware, pottery, etc.) 8.00‰
- Vehicles (cars, motorcycles, etc.)
Base premiums plus 50.00%
- Livestock 30.00‰
- Perishable goods (plants, fruits, flowers, meat, pharmaceutical, chemical, etc.) 30.00‰
- Frozen goods 7.50‰
- Refrigerated goods 12.00‰
- Watches
- Mobile phones
Base premium plus 50%

Additional premiums

- For delays exceeding 60 days, for each additional period of 30 days commenced 1.0‰
- For war, strikes, disturbance and terrorism on request
- For overland transport to/from the airport of departure/destination in excess of 750 km or 450 miles each 1.0‰

Insurance

Species (SWISS Valuables)

Insurance cover species (SWISS Valuables)

Valuable cargo means a consignment which contains more of the following articles:

1. Any article having a declared value for carriage of USD 1'000.00 (or its equivalent) or more, per gross kilogram.
2. Gold bullion (including refined and unrefined gold in ingot form), dore bullion, gold specie, B. Gold only in the form of grain, sheet, foil, powder, sponge, wire, rod, tube, circles, mouldings and castings, A. Platinum, platinum metals (palladium, iridium, ruthenium, osmium and rhodium), Platinum alloys in the form of grain, sponge, bar, ingot, sheet, rod, wire, gauze, tube and strip, provided that those radioactive isotopes of the above metals and alloys are dangerous goods.
3. Legal bank notes, traveller's cheque, securities, shares and share coupons, postage stamps and revenue stamps (excluding mint), ready for use bank cards and/or credit cards.
4. A. Diamonds (including diamonds for industrial use), rubies, emeralds, sapphires, opals and real pearls (including cultured pearls), I B. Jewelry consisting of any of the articles under A. above.
5. Jewelry and watches made of platinum and/or gold and/or silver, and
6. Articles made of platinum and/or gold, other than platinum and/or gold plated.

Insurance

Species (SWISS Valuables)

Scope of insurance

The insurance covers loss or damage as per the special conditions of the open cover for species. In the case of accompanied consignments, theft and loss are only insured if violence is threatened or used or if no resistance can be offered as a result of death or injury of the person charged with effecting the carriage.

Unless otherwise agreed, war, strike, disturbances and terrorism risks are not included.

Duration of insurance

The insurance is operative from warehouse to warehouse, It attaches as soon as the species/valuables are removed from their present place for immediate transportation and terminates as soon as they are delivered to the place specified by the consignee.

For shipment of species, collection from or delivery to the airports is covered, even when undertaken by the consignee or consignor.

Note:

Transport to the airport of departure is only insured on condition that a specific request to this effect is made to LX or an IATA air cargo agent before commencement of the risk (i.e. on advice of shipment).

Storage during transit is covered up to 60 days any one storage.

Security measures (land)

For species adequate security measures for overland transports will be required (security vans and/or armored cars) under consideration of the insured value of the species. Please inquire with Swiss WorldCargo, Claims Management, P.O. Box ZRHS/LB-OS, CH-8058 Zurich Airport.

Forwarding instruction (air)

Species have to be forwarded as "valuable cargo". They must be expressly indicated as "VAL" in the AWB and SWISS Worx and must be handled according to current CHM instructions.

Insurance

Species (SWISS Valuables)

Insurance premium

The premium is calculated on the basis of the insurance value. The minimum per insured consignment is CHF 20.– or the equivalent in other currencies.

Insurance zones

Zone 1: Europe, including European part of Turkey

Zone 2: North America, including Mexico

Zone 3: Central and South America

Zone 4: Africa

Zone 5: Asia, including Asian part of Turkey /
Middle East / Australia and Oceania

Tariff "species" (SWISS Valuables)

Zone	1	2	3	4	5
	‰	‰	‰	‰	‰
1	0.5	0.75	2.5	1.75	2.0
2	0.75	0.5	2.5	1.75	2.0
3	2.5	2.5	2.0	2.5	2.5
4	1.75	1.75	2.5	1.75	2.0
5	2.0	2.0	2.5	2.0	1.75

‰ per mille of the insurable value

Additional premiums

- For delays exceeding 60 days, for each additional period of 30 days commenced 1.0‰
- For war and strikes, disturbances and terrorism on request
- For overland transport to/from the airport of departure/destination in excess of 750 km or 450 miles each on request 1.0‰

Insurance

Exclusions and claims

General exclusions (extract of the conditions)

The consequences of confiscation, seizure or detention by a government, authority or power, delay howsoever caused, in transit or delivery, wilful misconduct of the assured, infringement of import, export or transit regulations, infringement of carrier's regulations, false declaration.

Also excluded is damage attributable to: humidity of the air, influence of temperature unless specially agreed prior to the commencement of the risk, the nature of the goods such as self-deterioration, heating, spontaneous combustion, shrinkage, wastage, vermin originating in the goods insured, unsuitable condition of the goods for the insured voyage, inadequate packing, normal wear and tear, damage caused by nuclear energy, indirect losses of all kinds such as loss of interest, difference of exchange, loss of market, consequential loss. The insurer is released from all liability if his regulations concerning dispatch and limits are not adhered to or if with the insured's knowledge the agreed safety measures are not adhered to, the journey or the means of conveyance do not correspond to the agreement, the species are carried by inappropriate vehicles or routes are used which are unsuitable. Unless otherwise agreed prior to the commencement of the risk the insurer is not liable for political or social risks such as war, warlike occurrences, strike, lockout and disturbances of whatever kind, violent or malicious acts. The risk of terrorism for all transport related delays/storages exceeding 60 days. For permanent storage the risk of terrorism is generally excluded.

What to do in case of loss or damage

The assured must notify the insurer without any delay of any loss or damage which comes to his knowledge.

Furthermore, in the event of loss or damage it is the duty of the assured to take forthwith all measures for the preservation and salvage of the goods and for minimising the loss or damage.

The insurer also may take such measures. In the event of non-compliance with these obligations, the indemnification can be reduced commensurate with the assured's degree of fault.

All rights of recovery against third parties who may be held responsible for the loss or damage shall be preserved. In particular, the following steps are to be taken:

- a. Outward apparent loss or damage must be notified to the carrier in writing before delivery of the goods is taken.
- b. Whenever loss or damage is presumed, valid reserves must be lodged within the period prescribed by law or by contract.
- c. The carrier must be summoned to a joint survey of the loss or damage. The assured is responsible for all acts or omissions which prejudice the right of recovery.

Insurance

Exclusions and claims

Claim regulations

To justify his title to claim for loss or damage, the claimant must provide the insurer with such original documents as are available, i.e.:

- Air waybill
- Commercial invoice, packing list (inventory indicating values, if no commercial shipment involved)
- Survey report by the carrier
- Copy of the notification of reserves to the carrier
- And, if available:
 - Insurance certificate
 - Survey report by the claim agent

Claim documents shall be sent by the claim-receiving LX representation to Swiss WorldCargo, Claims Management, P.O. Box ZRHLX/CSS, CH-8058 Zurich Airport, for processing with the insurers.

Separate legal indication

The insurance is based on the following conditions:
Institute Cargo Clauses

This policy shall be governed by the German law and the German courts shall have sole jurisdiction in any dispute arising hereunder. In case one provision contradicts such applicable law, only this provision shall be deemed void, all other provisions remain in force as agreed.

Transport to the airport of departure is only insured on condition that a specific request to this effect is made to SWISS or an IATA Cargo Agent before commencement of the risk (i.e. on advice of shipment)

Place of jurisdiction is Cologne (Germany). All rights against the insurer are forfeited unless suit is brought within two years of the event giving rise to the claim.

Further information

Further information is available from your nearest representation of Swiss WorldCargo or from the Head Office of Swiss WorldCargo in Zurich – Swiss WorldCargo, Claims Management, P.O. Box ZRHS/LB-OS, CH-8058 Zurich Airport, cargo.claims@swiss.com

Your cargo contacts

Swiss WorldCargo offices

- Ahmedabad**
India
☎ +91 79 26464504
☎ +91 79 26466764
☎ +91 79 26466813
cargo.ahmedabad@swiss.com
- Amsterdam**
Netherlands
☎ +31 20 8090 466
cargo.netherlands@swiss.com
- Athens**
Greece
☎ +30 210 35 43 898/9
cargo.greece@swiss.com
- Atlanta**
USA
☎ +1 724 572 82 77
cargo.atlanta@swiss.com
- Bangkok**
Thailand
☎ +66 2 134 3039
cargo.thailand@swiss.com
- Barcelona**
Spain
☎ +34 91 312 07 50
cargo.spain@swiss.com
- Basel/Mulhouse/
Freiburg**
Switzerland
☎ +41 61 582 24 70
☎ +41 61 582 18 95
cargo.basel@swiss.com
Import
☎ +41 61 325 24 40
☎ +41 61 325 24 56
- Beijing**
China
☎ +86 10 6945 0450
☎ +86 10 6945 0449
cargo.beijing@swiss.com
- Belgrade**
Republic of Serbia
c/o Sky Cargo Group
☎/☎ +381 11 2097 402
cargo.serbia@swiss.com
- Belo Horizonte**
Brazil
c/o Europlus Cargo
☎ +55 51 32262865
cargo.brazil.gssa@swiss.com
- Berlin**
Germany
Berlin
☎ +49 69 69 710 0
cargo.germany@swiss.com
- Berne**
Switzerland
(for freight forwarders)
☎ +41 848 80 20 00
☎ +41 44 564 53 33
cargo.sales@swiss.com
(for private customers)
c/o Cargologic Ltd.
☎ +41 31 381 79 86
☎ +41 31 381 79 81
cargo.export.berne@swiss.com
Import
☎ +41 31 381 79 79
☎ +41 31 381 79 81
cargologic.bern@
cargologic.com
- Billund**
Denmark
c/o Airtrade
☎ +45 3231 4286
cargo.denmark@swiss.com
- Birmingham**
United Kingdom
☎ +44 844 8888 724
☎ +44 844 8888 725
cargo.unitedkingdom@swiss.com
- Bologna**
Italy
☎ +39 02 0070 3666
cargo.italy@swiss.com
- Bordeaux**
France
☎ +33 17 327 49 50
☎ +33 141 846 814
cargo.france@swiss.com
- Boston**
USA
☎ +1 724 572 8244
cargo.bos@swiss.com
- Bratislava**
Slovakia
☎ +420 220 114 081
cargo.czechrepublic@swiss.com
- Bremen**
Germany
☎ +49 69 69 710 0
cargo.germany@swiss.com
- Brussels**
Belgium
☎ +32 2 257 03 30
cargo.belgium@swiss.com
- Bucharest**
Romania
c/o Kales Airline Services
S.R.L.
☎ +40 730 102 704
cargo.romania@swiss.com
- Budapest**
Hungary
☎ +36 29 789 901
☎ +36 29 789 902
☎ +36 29 789 904
cargo.hungary@swiss.com
- Buenos Aires**
Argentina
c/o Crossracer International SA
Town Office
☎ +54 11 4322 4222
☎ +54 11 4328 9676
Sales
cargo.argentina@swiss.com
Import Export
swissworldcargo.handling.
ar@crossracer.aero
Airport Import
☎ +54 11 5480 0157
☎ +54 11 4897 4042
cargo.argentina@swiss.com
Airport Export
☎ +54 11 4897 4040
☎ +54 11 4897 4042
cargo.argentina@swiss.com
- Calgary**
Canada
☎ +1 514 422 8030
cargo.canada@swiss.com
- Cancun**
Mexico
☎ +1 724 572 8277
cargo.mexico@swiss.com
- Cape Town**
South Africa
☎ +27 11 390 2449
☎ +27 71 377 7964
(operation)
cargo.southafrica@swiss.com
- Chicago**
USA
☎ +1 724 572 8233
cargo.ord@swiss.com
- Cleveland**
USA
☎ +1 724 572 8233
cargo.ord@swiss.com
- Cologne**
Germany
☎ +49 69 69 710 0
cargo.germany@swiss.com
- Colombo**
Sri Lanka
☎ +94 11 243 54 03/4/5
☎ +94 11 232 90 92
cargo.srilanka@swiss.com
- Copenhagen**
Denmark
c/o Airtrade
☎ (+45) 3231 4286
cargo.denmark@swiss.com
- Cork**
Ireland
☎ +353 1 861 2276
☎ +353 1 861 2257
cargo.ireland@swiss.com
- Curitiba**
Brazil
c/o Europlus Cargo
☎ +55 51 32262865
cargo.brazil.gssa@swiss.com

Your cargo contacts

- Delhi**
India
☎ +91 11 4705 7014 -18
☎ +91 11 4705 7020
cargo.delhi@swiss.com
- Denver**
USA
☎ +1 724 572 8255
cargo.lax@swiss.com
- Detroit**
USA
☎ +1 724 572 8233
cargo.ord@swiss.com
- Dhaka**
Bangladesh
☎ +880 2 895 6374
☎ +880 2 883 5028
cargo.bangladesh@swiss.com
- Dresden**
Germany
☎ +49 69 69 710 0
cargo.germany@swiss.com
- Dubai**
United Arab Emirates
☎ +971 4 606 44 99
☎ +971 4 299 15 23
cargo.dubai@swiss.com
- Dublin**
Ireland
☎ +353 1 861 2276
☎ +353 1 861 2257
cargo.ireland@swiss.com
- Dusseldorf**
Germany
☎ +49 69 69 710 0
cargo.germany@swiss.com
- Edinburgh**
United Kingdom
☎ +44 844 8888 724
☎ +44 844 8888 725
cargo.unitedkingdom@swiss.com
- El Paso**
USA
☎ +1 724 572 8255
cargo.lax@swiss.com
- Florence**
Italy
☎ +39 02 0070 3666
cargo.italy@swiss.com
- Florianopolis**
Brazil
c/o Europlus Cargo
☎ +55 51 32262865
cargo.brazil.gssa@swiss.com
- Frankfurt**
Germany
☎ +49 69 69 710 0
cargo.germany@swiss.com
- Geneva**
Switzerland
☎ +41 22 591 83 00
cargo.geneva@swiss.com
Import
☎ +41 22 799 23 96
- Glasgow**
United Kingdom
☎ +44 844 8888 724
☎ +44 844 8888 725
cargo.unitedkingdom@swiss.com
- Gothenburg**
Sweden
c/o Air Trade Support
☎ +46 8 59788 990
cargo.sweden@swiss.com
- Graz**
Austria
☎ +43 1 395 092 40
cargo.austria@swiss.com
- Hamburg**
Germany
☎ +49 69 69 710 0
cargo.germany@swiss.com
- Hanoi**
Vietnam
c/o ECS Group
☎ +84 4 3564 3719
cargo.vietnam@swiss.com
- Hanover**
Germany
☎ +49 69 69 710 0
cargo.germany@swiss.com
- Helsinki**
Finland
c/o Lufthansa Cargo
☎ +44 844 8888 724
cargo.unitedkingdom@swiss.com
- Ho Chi Minh City**
Vietnam
c/o ECS Group
☎ +84 4 3225 2542
☎ +84 8 3547 2151
cargo.vietnam@swiss.com
- Hohenems/Dornbirn**
Austria
Sales Office import/export
(for freight forwarders)
SWISS Valuables
☎ +41 848 80 30 00
All other products
☎ +41 848 80 20 00
☎ +41 44 564 53 33
cargo.sales@swiss.com
- Hong Kong**
China
☎ +852 2769 8725
☎ +852 2764 6561
cargo.hongkong@swiss.com
- Innsbruck**
Austria
☎ +43 1 395 092 40
cargo.austria@swiss.com
- Johannesburg**
South Africa
☎ +27 11 390 2449
☎ +27 71 377 7964
(operation)
cargo.southafrica@swiss.com
- Joinville**
Brazil
c/o Europlus Cargo
☎ +55 51 32262865
cargo.brazil.gssa@swiss.com
- Kiev**
Ukraine
c/o FF Cargo Services
☎ +380 44 591 7894
cargo.ukraine@swiss.com
- Kolkata/Calcutta**
India
☎ +91 33 4062 3210
cargo.kolkata@swiss.com
- Krakow**
Poland
☎ +48 22 33 20 551/2/3
cargo.poland@swiss.com
- Larnaca**
Cyprus
c/o LGS Handling
☎ +357 2 4008500/1
lca.cargo@gshandling.com
- Las Palmas**
Spain
☎ +34 91 312 07 50
cargo.greece@swiss.com
- Las Vegas**
USA
☎ +1 724 572 8255
cargo.lax@swiss.com
- Leipzig/Halle**
Germany
☎ +49 69 69 710 0
cargo.germany@swiss.com
- Lille**
France
☎ +33 17 327 49 50
☎ +33 141 846 814
cargo.france@swiss.com
- Lima**
Peru
☎ +1 724 572 8277
cargo.mia@swiss.com
- LinZ**
Austria
☎ +43 1 395 092 40
cargo.austria@swiss.com
- Lisbon**
Portugal
c/o Global Aviation Cargo
☎ +35 1 963 174 856
cargo.portugal@swiss.com
- Ljubljana**
Slovenia
☎ +43 1 395 092 40
cargo.austria@swiss.com
- Lódź**
Poland
☎ +48 22 33 20 551/2/3
cargo.poland@swiss.com

Your cargo contacts

London

United Kingdom
☎ +44 844 8888 724
☎ +44 844 8888 725
cargo.unitedkingdom@swiss.com

Los Angeles

USA
☎ +1 724 572 8255
cargo.lax@swiss.com

Luxembourg

Luxembourg
☎ +32 2 257 03 30
cargo.belgium@swiss.com

Lyon

France
☎ +41 22 591 83 00
☎ +41 22 799 23 76
cargo.lyon@swiss.com

Madrid

Spain
☎ +34 91 312 07 50
cargo.spain@swiss.com

Málaga

Spain
☎ +34 91 312 07 50
cargo.spain@swiss.com

Male

Maldives
☎ +94 11 243 54 03/4/5
☎ +94 11 232 90 92
cargo.maldives@swiss.com

Malmö

Sweden
c/o Air Trade Support
☎ +46 8 59788 990
cargo.sweden@swiss.com

Malta

Malta
cargo.malta@swiss.com

Manchester

United Kingdom
☎ +44 844 8888 724
☎ +44 844 8888 725
cargo.unitedkingdom@swiss.com

Marseille

France
☎ +33 17 327 49 50
☎ +33 141 846 814
cargo.france@swiss.com

Mauritius

Republic of Mauritius
c/o Cel Aviation
☎ +230 6379363
☎ +230 637 9364
cargo.mauritius@swiss.com

Miami

USA
☎ +1 724 572 8277
cargo.mia@swiss.com

Milan

Italy
☎ +39 02 0070 3666
cargo.italy@swiss.com

Montreal

Canada
☎ +1 514 422 8030
cargo.canada@swiss.com

Moscow

Russian Federation
☎ +7 495 961 38 20
cargo.russia@swiss.com

Muenster/Osnabrueck

Germany
☎ +49 69 69 710 0
cargo.germany@swiss.com

Mulhouse

France
☎ +41 61 582 24 70
☎ +41 61 582 18 95
cargo.basel@swiss.com

Mumbai/Bombay

India
Reservation
☎ +91 22 6177 4677/8
Sales
☎ +91 22 6177 4687/8
☎ +91 22 6177 4666
cargo.mumbai@swiss.com

Munich

Germany
☎ +49 69 69 710 0
cargo.germany@swiss.com

Muscat

Sultanate of Oman
☎ +968 24 356 971
cargo.oman@swiss.com

Nantes

France
☎ +33 17 327 49 50
☎ +33 141 846 814
cargo.france@swiss.com

Naples

Italy
☎ +39 02 0070 3666
cargo.italy@swiss.com

Navegantes

Brazil
c/o Europlus Cargo
☎ +55 51 32262865
cargo.brazil.gssa@swiss.com

Newark

USA
☎ +1 724 572 8222
☎ +1 724 572 8223
cargo.ewr@swiss.com

New York (JFK)

USA
☎ +1 724 572 8211
☎ +1 724 572 8212
cargo.jfk@swiss.com

Nice

France
☎ +33 17 327 49 50
☎ +33 141 846 814
cargo.france@swiss.com

Nuremberg

Germany
☎ +49 69 69 710 0
cargo.germany@swiss.com

Orlando

USA
☎ +1 724 572 8277
cargo.mia@swiss.com

Osaka

Japan
☎ +81 6 6347 8720
cargo.japan@swiss.com

Oslo

Norway
Air Trade Support AS
☎ +47 2240 3790
cargo.norway@swiss.com

Palma de Mallorca

Spain
☎ +34 91 312 07 50
cargo.spain@swiss.com

Paris

France
☎ +33 17 327 49 50
☎ +33 141 846 814
cargo.france@swiss.com

Philadelphia

USA
☎ +1 724 572 8222
☎ +1 724 572 8223
cargo.ewr@swiss.com

Phnom Penh

Cambodia
☎ +855 23 230 618
☎ +855 12 503 898
☎ +855 92 468 999
cargo.cambodia@swiss.com

Phoenix

USA
☎ +1 724 572 8255
cargo.lax@swiss.com

Phuket

Thailand
☎ +66 2 134 3039
cargo.thailand@swiss.com

Porto

Portugal
c/o Global Aviation Cargo
☎ +351 963 174 856
cargo.portugal@swiss.com

Porto Alegre

Brazil
c/o Europlus Cargo
☎ +55 51 32262865
cargo.brazil.gssa@swiss.com

Prague

Czech Republic
☎ +420 220 114 081
cargo.czechrepublic@swiss.com

Pristina

Kosovo
☎ +381 38 59 58 177
☎ +381 38 59 58 174
cargoprno@limakkosovo.aero

Your cargo contacts

Punta Cana

Dominican Republic
☎ +1 809 959 0023
☎ +1 809 221 1273
cargo.dominicanrepublic@swiss.com
Handling: puj.cargo@caribecargo.net

Rennes

France
☎ +33 17 327 49 50
☎ +33 141 846 814
cargo.france@swiss.com

Rio de Janeiro

Brazil
☎ +55 11 2445 5010
ext. 218
Reservation
cargo.brazil@swiss.com
Cargo Operations
swissworldcargo.brazil@crossracer.com.br

Rome

Italy
☎ +39 02 0070 3666
cargo.italy@swiss.com

Saint Petersburg

Russian Federation
c/o FF Cargo Services
☎ +7 812 603 46 53
☎ +7 495 648 65 01 (ext. 1)
cargo.stpetersburg@swiss.com

Salt Lake City

USA
☎ +1 724 572 8255
cargo.lax@swiss.com

Salzburg

Austria
☎ +43 1 395 092 40
cargo.austria@swiss.com

San Diego

USA
☎ +1 724 572 8255
cargo.lax@swiss.com

San Francisco

USA
☎ +1 724 572 8266
☎ +1 724 572 8267
cargo.sfo@swiss.com

San José

Costa Rica
c/o AmericasGSA
☎ +1 506 8302 1133
cargo.costarica@swiss.com

Santo Domingo

Dominican Republic
☎ +1 809 549 0111
☎ +1 809 549 0552
cargo.dominicanrepublic@swiss.com
Export
sdq.ops@caribecargo.net
Import
sdq.traffic@caribecargo.net

Santiago de Chile

c/o HAE GSA
☎ +56 2 3263 9420
cargo.chile@swiss.com

São Paulo

Brazil
LX Sales Office
☎ +55 11 2445 5010
LX Cargo Operations
☎ + 55 11 2445 6044
ext. 218
Reservation
cargo.brazil@swiss.com
Cargo Operations
swissworldcargo.brazil@crossracer.com.br

Shanghai

China
☎ +86 21 6835 2190/2199
ext. 187-191
☎ +86 21 6835 2180
cargo.shanghai@swiss.com

Shannon

Ireland
☎ +353 1 861 2276
☎ +353 1 861 2257
cargo.ireland@swiss.com

Singapore

Singapore
☎ +65 3157 0640
☎ +65 6542 3611
cargo.singapore@swiss.com

Skopje

Austria
☎ +43 1 7007 72400
cargo.austria@swiss.com

Sofia

Bulgaria
c/o Globe Air Cargo
cargo.bulgaria@swiss.com

Stockholm

Sweden
c/o Air Trade Support
☎ +46 8 59788 990
cargo.sweden@swiss.com

Strasbourg

France
☎ +41 61 582 24 70
☎ +41 61 582 18 95
cargo.basel@swiss.com

Import

☎ +33 3 67 65 00 40

Stuttgart

Germany
☎ +49 69 69 710 0
cargo.germany@swiss.com

Taipei

Taiwan
☎ +886 2 2503 4123
ext. 888
☎ +886 2 2503 4122
cargo.taiwan@swiss.com

Tampa

USA
☎ +1 724 572 8277
cargo.mia@swiss.com

Tel Aviv

Israel
Export
☎ +972 3 971 82 82
☎ +972 3 972 10 32
cargo.israel@swiss.com
Import
☎ +972 3 971 82 92
☎ +972 3 972 10 32
cargoimp.israel@swiss.com

Tenerife South

Spain
☎ +34 91 312 07 50
cargo.spain@swiss.com

Thessaloniki

Greece
Reservation
☎ +30 210 3543898/9
cargo.greece@swiss.com
Operations
☎ +30 2310 473823
skg.cargoservices@swissport.gr

Tokyo

Japan
Reservation/Sales
☎ +81 3 5405 4911
cargo.japan@swiss.com

Toronto

Canada
☎ +1 905 676 3261
cargo.toronto@swiss.com

Toulouse

France
☎ +33 17 327 49 50
☎ +33 141 846 814
cargo.france@swiss.com

Tucson

USA
☎ +1 724 572 8255
cargo.lax@swiss.com

Turin

Italy
☎ +39 02 0070 3666
cargo.italy@swiss.com

Valencia

Spain
☎ +34 91 312 07 50
cargo.spain@swiss.com

Vancouver

Canada
☎ +1 514 422 8030
cargo.canada@swiss.com

Venice

Italy
☎ +39 02 0070 3666
cargo.italy@swiss.com

Verona

Italy
☎ +39 02 0070 3666
cargo.italy@swiss.com

Vienna

Austria
☎ +43 1 395 092 40
cargo.austria@swiss.com

Your cargo contacts

Warsaw

Poland

☎ +48 22 33 20 551/2/3

✉ cargo.poland@swiss.com

Washington

USA

☎ +1 724 572 8222

☎ +1 724 572 8223

✉ cargo.ewr@swiss.com

Wroclaw

Poland

☎ +48 22 33 20 551/2/3

✉ cargo.poland@swiss.com

Zurich

Switzerland

Sales Office import/export

(for freight forwarders)

SWISS Valuables

☎ +41 848 80 30 00

All other products

☎ +41 848 80 20 00

☎ +41 44 564 53 33

✉ cargo.sales@swiss.com

Export

(for private customers)

☎ +41 44 564 54 54

☎ +41 44 564 54 64

✉ cargo.export.zurich@

swiss.com

Calendar

Kalender

Calendrier

Jan 2024								Feb 2024								Mar 2024								
M	T	W	T	F	S	S		M	T	W	T	F	S	S		M	T	W	T	F	S	S		
1	1	2	3	4	5	6	7	5				1	2	3	4	9						1	2	3
2	8	9	10	11	12	13	14	6	5	6	7	8	9	10	11	10	4	5	6	7	8	9	10	
3	15	16	17	18	19	20	21	7	12	13	14	15	16	17	18	11	11	12	13	14	15	16	17	
4	22	23	24	25	26	27	28	8	19	20	21	22	23	24	25	12	18	19	20	21	22	23	24	
5	29	30	31					9	26	27	28	29				13	25	26	27	28	29	30	31	

Apr 2024								May 2024								Jun 2024								
M	T	W	T	F	S	S		M	T	W	T	F	S	S		M	T	W	T	F	S	S		
13	1	2	3	4	5	6	7	18			1	2	3	4	5	22							1	2
14	8	9	10	11	12	13	14	19	6	7	8	9	10	11	12	23	3	4	5	6	7	8	9	
15	15	16	17	18	19	20	21	20	13	14	15	16	17	18	19	24	10	11	12	13	14	15	16	
16	22	23	24	25	26	27	28	21	20	21	22	23	24	25	26	25	17	18	19	20	21	22	23	
17	29	30						22	27	28	29	30	31			26	24	25	26	27	28	29	30	

Jul 2024								Aug 2024								Sep 2024							
M	T	W	T	F	S	S		M	T	W	T	F	S	S		M	T	W	T	F	S	S	
27	1	2	3	4	5	6	7	31				1	2	3	4	35							1
28	8	9	10	11	12	13	14	32	5	6	7	8	9	10	11	36	2	3	4	5	6	7	8
29	15	16	17	18	19	20	21	33	12	13	14	15	16	17	18	37	9	10	11	12	13	14	15
30	22	23	24	25	26	27	28	34	19	20	21	22	23	24	25	38	16	17	18	19	20	21	22
31	29	30	31					35	26	27	28	29	30	31		39	23	24	25	26	27	28	29
																40	30						

© Copyright 2024. Swiss WorldCargo / ZRHLX/LM / March 2024.
 Subject to government approvals and alterations without prior notice.